

Master

INSTRUCTION MANUAL

MODEL 153

MICROVOLT-AMMETER

© COPYRIGHT 1974

KEITHLEY INSTRUMENTS, INC.

28775 AURORA ROAD • CLEVELAND, OHIO 44139 • (216) 248-0400
TELEX: 98-5469 • CABLE: KEITHLEY

PRINTED IN U.S.A.

CONTENTS

<u>SECTION</u>	<u>PAGE</u>
SPECIFICATIONS -----	iv
1. GENERAL DESCRIPTION -----	1
2. OPERATION -----	3
3. APPLICATIONS -----	12
4. CIRCUIT DESCRIPTION -----	13
5. SERVICING -----	17
6. CALIBRATION -----	23
7. ACCESSORIES -----	33
8. REPLACEABLE PARTS -----	37
SCHEMATIC -----	45

ILLUSTRATIONS

Fig. No.	Title	Page
1	Model 153 Front Panel. -----	2
2	Front Panel Controls. -----	4
3	Rear Panel Terminals. -----	5
4	Thermal Sink Construction. -----	10
5	Using Model 153 with 4-Terminal Connections. -----	11
6	Null Circuit and Leads and Northrup K3 Potentiometer. -----	12
7	Diagram Showing Currents in Solid State Circuits. -----	12
8	Circuit for Semiconductor Resistivity Measurements. -----	12
9	Model 153 Block Diagram. -----	13
10	Wave Form at Junction of Diodes D301 and D302. -----	18
11	Wave Form at Junction of Resistor R302 and Capacitor C302B. -----	18
12	Wave Form at -13 Volt Supply. -----	18
13	Divider Connection for Multivibrator Frequency Adjustment. -----	20
14	Wave Form of Multivibrator Output. -----	20
15	Wave Form for Tuned Multivibrator Output Across Resistor R121. ---	20
16	Wave Form for Input Modulator E101. -----	20
17	Demodulator Wave Form for Full-Scale Input on 1-Volt Range. -----	21
18	Typical Model 153 Drift Chart. -----	25
19	Model 153 Interior. -----	26
20	Model 153 Interior. -----	27
21	Capacitor, Tube, Battery, and Modulator Locations on PC-106. -----	28
22	Resistor Locations on Printed Circuit Board PC-106. -----	29
23	Component Locations for Printed Circuit Board PC-107. -----	30
24	Component Locations on Model 153 Rear Chassis Panel. -----	30
25	Component Locations on Range Switch S1. -----	31
26	Component Locations on Range Switch S1. -----	31
27	Component Locations for Model 153 Power Supply and Multivibrator. -----	32
28	Keithley Instruments Model 1531 Gripping Probe. -----	33
29	Keithley Instruments Model 1532 Test Leads. -----	33
30	Keithley Instruments Model 1533 Mating Connector. -----	33
31	Model 1483 Low-Thermal Connection Kit. -----	34
32	Keithley Instruments Model 6012 Triaxial-to-Coaxial Adapter. -----	34
33	Exploded View of Model 4005 Rack Mounting Kit. -----	35

SPECIFICATIONS

AS A VOLTMETER AND NULL DETECTOR

RANGE: 10 microvolts full scale to 1000 volts in 17 overlapping 1x and 3x ranges.

ACCURACY: (exclusive of noise and drift):

- ±1% of full scale on 3-microvolt to 1000-volt ranges.
- ±2% of full scale on 1000-microvolt to 1-millivolt ranges.
- ±3% of full scale on 10 and 30-microvolt ranges.

ZERO DRIFT: Less than ±2 microvolts per 24 hours after warm-up with reasonably constant ambient temperature. Less than 8 microvolts during 2-hour warm-up. Long term drift is noncumulative.

INPUT NOISE: With input shorted, less than 0.06 microvolt rms (0.3 microvolt peak-to-peak) on most sensitive range. With 1-megohm source, less than 0.1 microvolt rms (0.5 microvolt peak-to-peak) on most sensitive range.

INPUT RESISTANCE:

- Greater than 200 megohms on 100-microvolt to 1000 volt ranges.
- Greater than 50 megohms on 30-microvolt range.
- Greater than 20 megohms on 10-microvolt range.

Note: input resistance of any range may be shunted by a 2-megohm resistor by using the Function switch.

LINE FREQUENCY REJECTION: A voltage of power line or twice power line frequency which is 40 dB (p-p/dc) greater than full scale affects reading less than 0.5%.

RISE TIME (10% to 90%): Less than 1 second on 100-microvolt to 1000-volt ranges. Less than 5 seconds on 10 and 30-microvolt ranges.

AS AN AMMETER

RANGE: 10^{-11} ampere full scale to 10^{-1} ampere in 21 overlapping 1x and 3x ranges.

ACCURACY: (exclusive of noise and drift):

- ±2% of full scale on 3×10^{-4} to 10^{-1} ampere ranges.
- ±3% of full scale on 10^{-9} to 10^{-4} ampere ranges.
- ±4% of full scale on 10^{-11} and 3×10^{-11} ampere ranges.

ZERO DRIFT: Less than $\pm 2 \times 10^{-12}$ ampere per 24 hours after warm-up with reasonably constant ambient temperature. Less than 8×10^{-12} ampere during 2-hour warm-up.

INPUT NOISE (with input open): Less than 0.1×10^{-12} ampere rms (0.5 $\times 10^{-12}$ ampere p-p) on most sensitive range.

INPUT RESISTANCE: One ohm on 10^{-11} ampere range, increasing to one megohm on 10^{-1} ampere range.

RISE TIME (10% to 90%): Less than 2 seconds on 10^{-9} to 10^{-1} ampere ranges. Less than 5 seconds on 10^{-11} and 3×10^{-11} ampere ranges.

GENERAL

POLARITY: Meter switch selects left-zero (positive or negative) or center-zero scales. Recorder output polarity is not reversed.

ISOLATION: Circuit ground to chassis ground: Greater than 10^6 ohms shunted by $0.05 \mu\text{F}$. Circuit ground may be floated up to ± 500 volts dc or peak with respect to chassis ground.

RECORDER OUTPUT:

Output: 0 to ± 1 volt (adjustable) at up to 1 milliamperes for full-scale meter deflection on any range.

Resistance: Less than 10 ohms with output potentiometer set for maximum output.

Voltage Gain: 1 volt/Voltage setting in volts.

Noise: Input noise times voltage gain plus modulation products.

Modulation Products: Less than 5% peak-to-peak of full scale with input shorted.

CONNECTORS: Input: Special Triaxial. Output: Binding posts.

POWER: 105-125 or 210-250 volts (switch selected), 50-60 Hz, 35 watts.
DIMENSIONS, WEIGHT: Overall bench size 7 in. high x 11 in. wide x 11½ in. deep (175 x 275 x 285 mm). Net weight, 13 pounds (5.9 kg).

ACCESSORIES SUPPLIED: Model 1532 Low-Thermal Test Leads: mating connector, 3 ft. (1 m) low-thermal triaxial cable, alligator clips.



KEITHLEY INSTRUMENTS, INC.

INSTRUCTION MANUAL CHANGE NOTICE MODEL 153 MICROVOLT-AMMETER

INTRODUCTION: Since Keithley Instruments is continually improving product performance and reliability, it is often necessary to make changes to Instruction Manuals to reflect these improvements. Also, errors in Instruction Manuals occasionally occur that require changes. Sometimes, due to printing lead time and shipping requirements, we can't get these changes immediately into printed Manuals. The following new change information is supplied as a supplement to this Manual in order to provide the user with the latest improvements and corrections in the shortest possible time. Many users will transfer this change information directly to a Manual to minimize user error. All changes or additions are indicated in *italics*.

Page 41, Replaceable Parts, Resistors should read as follows:

R172	9.9k Ω	0.1%, 1/3W	W	15909	1250-9.9K Ω	R-110-9.9K	22
R173	100 Ω	0.1%, 1/3W	W	15909	1250-100 Ω	R-110-100	22

Pages 38 & 39, Replaceable Parts, Diodes, should read as follows:

D303	<i>Rectifier, 1.0A, 800V</i>	<i>1N4006</i>	<i>MOT</i>	<i>RF-38</i>	27
D304	<i>Rectifier, 1.0A, 800V</i>	<i>1N4006</i>	<i>MOT</i>	<i>RF-38</i>	27

SECTION 1. GENERAL DESCRIPTION

1-1. GENERAL.

a. The Keithley Model 153 Microvolt-Ammeter is a versatile dc instrument with high input impedance and low noise for measuring a wide range of voltages and currents. Its voltage ranges are from 5 microvolts full scale to 1000 volts, and its current ranges are from 10^{-11} ampere full scale to 0.1 ampere. The Model 153 has zero-center and zero-left meter scales.

b. Accuracy for the voltage ranges varies from $\pm 1\%$ of full scale on the 3-millivolt and higher ranges to $\pm 3\%$ of full scale on the 10 and 30-microvolt ranges. Accuracy for the current ranges varies from $\pm 2\%$ of full scale on the 3×10^{-9} ampere and higher ranges to $\pm 4\%$ of full scale on the 3×10^{-11} ampere and lower ranges.

c. Input resistance is 200 megohms for the 1-millivolt and higher ranges. Input resistance for the 10-microvolt range is 20 megohms. If a lower resistance is wanted, a front panel switch control allows shunting a 2-megohm resistor across the input.

d. Input noise on the most sensitive voltage range with the input shorted is less than 0.06 microvolt rms. Input noise on the most sensitive current range with the input open is less than 0.1×10^{-12} ampere rms.

1-2. FEATURES.

a. The Model 153 has excellent resolution for potentiometric null detector applications. Line frequency rejection is good; a power line or twice power line frequency which is 40 db (p-p/c) greater than full scale affects readings less than 0.5%. Isolation greater than 10^9 ohms from ground permits use in floating circuits.

b. The Model 153 uses the voltage drop method to measure currents. Input resistance as an ammeter varies from 1 megohm on the 10^{-11} ampere range to 1 ohm on the 0.1-ampere range. Voltage drop varies from 10 microvolts to 100 millivolts, depending upon the range used.

c. Recorder output is ± 1 volt dc at up to 1 milliampere for full-scale meter deflection on any range. The 1-milliampere capability permits use with recording galvanometers. Output resistance is less than 10 ohms with the output potentiometer set for maximum output. Drift is less than ± 2 microvolts per 24 hours.

1-3. APPLICATIONS.

a. As a voltmeter, the Model 153 is ideal for measuring a wide variety of voltages such as contact potentials, vacuum tube electrode potentials, biologically generated emf's, electro-chemical potentials, and power supply voltages. Other applications include use with various voltage generating transducers such as piezo-electric generators, Hall effect generators and strain gauges.

b. The Model 153 is also ideal for most null detector applications. On the three most sensitive ranges, power sensitivity is better than 5×10^{-21} watt. High ac rejection and floating capability make the Model 153 an ideal null detector for any bridge or potentiometer.

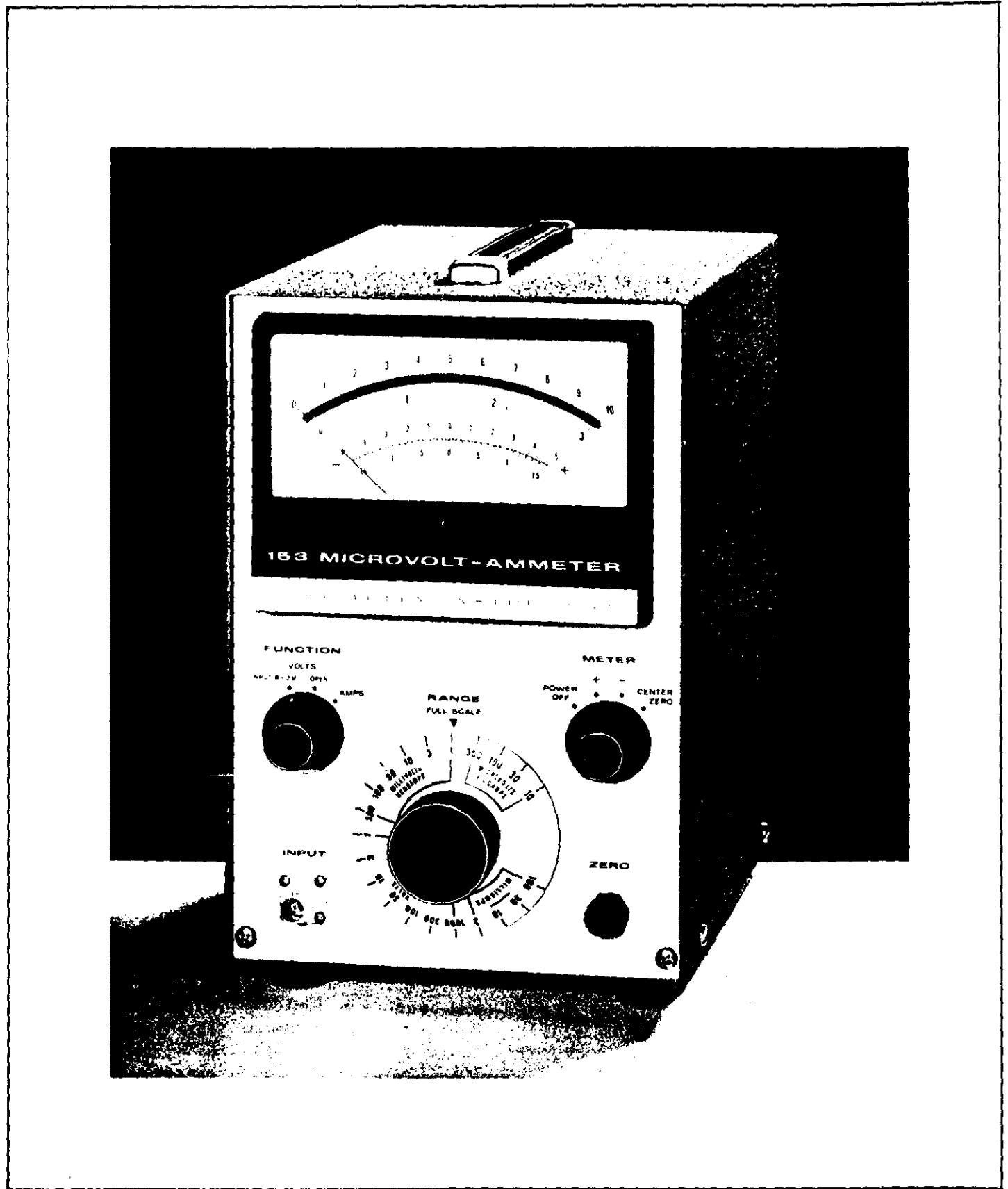

FIGURE 1. Model 153 Front Panel.

SECTION 2. OPERATION

2-1. FRONT PANEL CONTROLS AND TERMINALS.

- a. METER Switch. The METER Switch has four positions. POWER OFF shuts off the instrument; this also short circuits the meter, allowing accurate mechanical zero adjustment. METER + and METER - determine meter polarity. CENTER ZERO sets the instrument for center zero operation (lower meter scales).
- b. FUNCTION Switch. The FUNCTION Switch has three positions, two for voltage inputs and one for current inputs. In the VOLTS INPUT R-2M position, input resistance is approximately 2 megohms. In the VOLTS R-OPEN position, input resistance is at the maximum for the range being used. (See Table 1.) In the AMPS position, the Model 153 functions as an ammeter.
- c. RANGE Switch. The RANGE Switch selects the full-scale instrument sensitivity for one of 17 voltage and 21 current ranges. The 10 or 3 of the top meter scale corresponds to full-scale deflection for the range selected with the RANGE Switch.
- d. ZERO Control. The ZERO Control allows precise meter zeroing. Its range is about 20 microvolts, so it is most effective on the microvolt ranges. Since the 3-volt and higher ranges use a 1000:1 divider, the Control is also somewhat effective on the 3-volt range. It has much less effect on other ranges.
- e. INPUT Receptacle. The INPUT Receptacle is a Teflon-insulated Triaxial type connector. Its center terminal is the circuit high; the inner shield is circuit low (circuit ground); the outer shield is chassis ground.

2-2. REAR PANEL CONTROLS AND TERMINALS.

- a. DC OUTPUT ADJ Control. This Control sets the amplitude of the output voltage. Both the output voltage and resistance vary with the control setting. Voltage span is from 0 to 1.05 volts; output resistance varies to 7.5 kilohms maximum.
- b. Output Binding Posts. Three posts are used for the 1-volt recorder output. G is for case ground; LO is circuit ground; HI is the output connection. The furnished shorting link is for connecting the LO Post to the G Post.
- c. 117-234 Switch. The screwdriver-operated slide switch sets the Model 153 for 117 or 234-volt ac power lines.
- d. FUSE. For 105-125 volt operation, use a 1/2 ampere, 3 AG Slow Blow fuse. For 210-250 volt operation, use a 1/4 ampere, 3 AG Slow Blow fuse.
- e. Power Cord. The 3-wire power cord with the NEMA approved 3-prong plug provides a ground connection for the cabinet. An adapter for operation from 2-terminal outputs is provided.

NOTE

The Model 153 INPUT Receptacle is a Triaxial connector. Any attempt to connect bnc-type connectors to it may damage both.

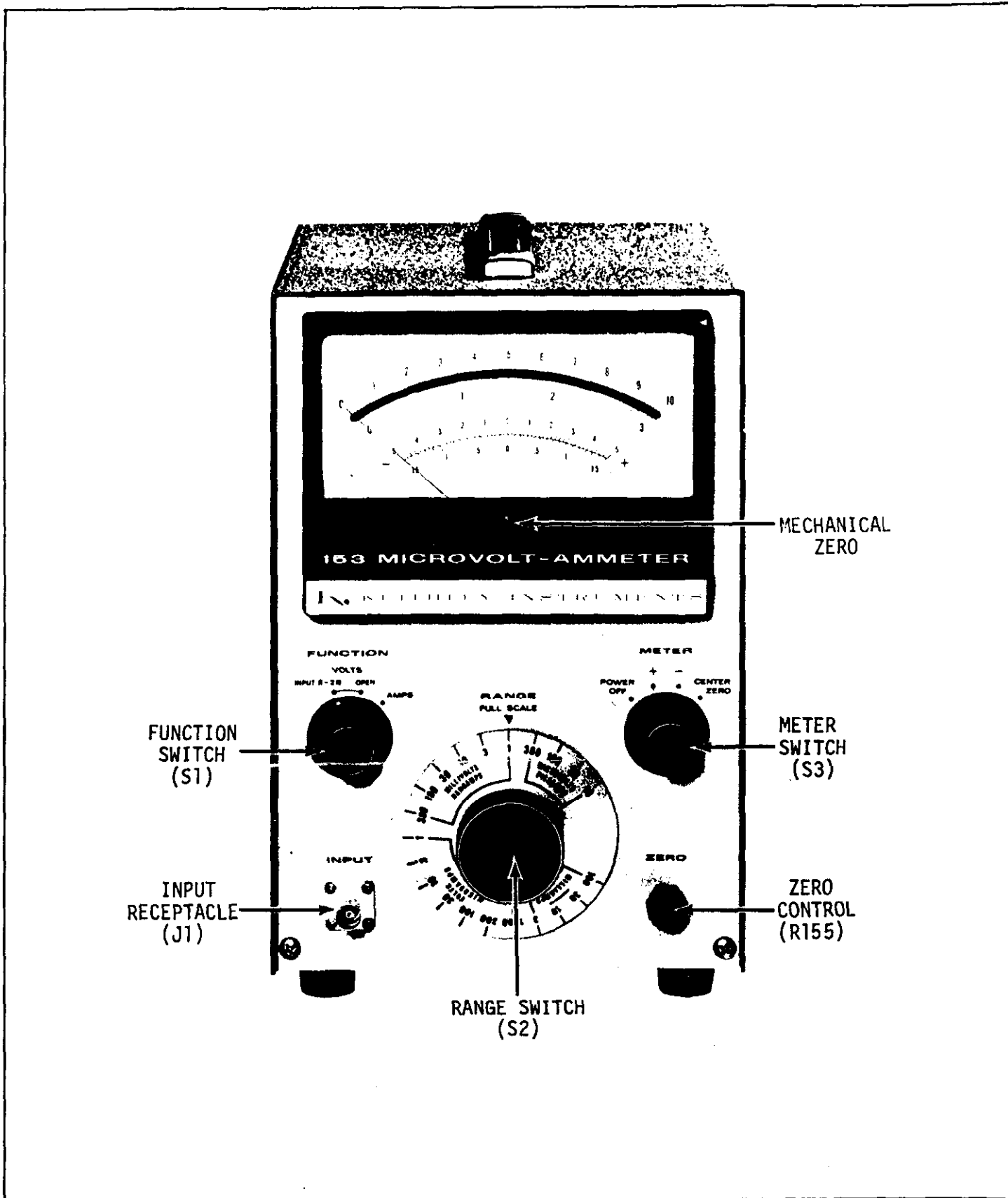

FIGURE 2. Front Panel Controls.

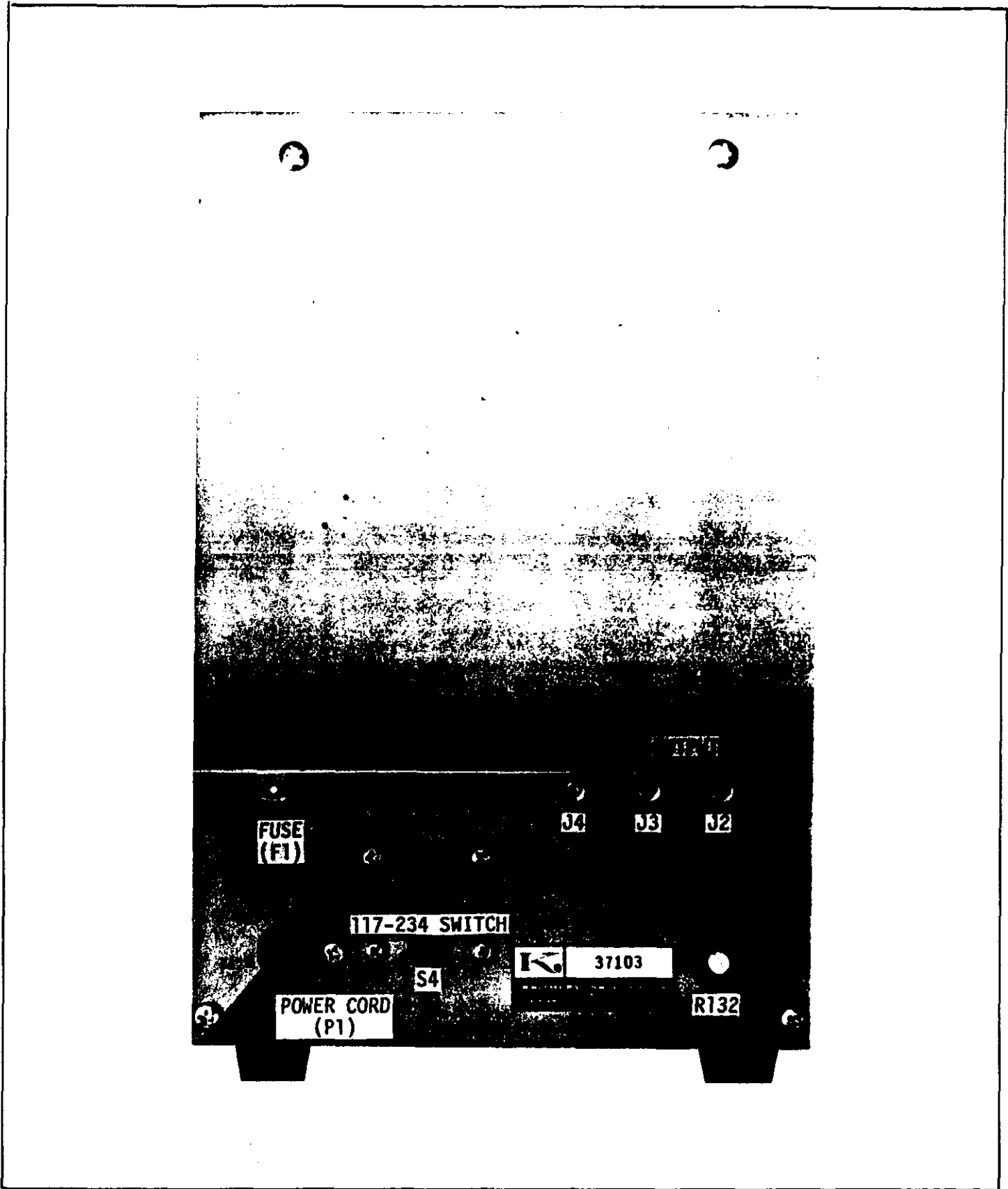

FIGURE 3. Rear Panel Terminals.

2-3. PRELIMINARY PROCEDURES.

- a. Check the 117-234 Switch and the Fuse for the proper ac line voltage.
- b. Set the controls as follows:

METER Switch	POWER OFF
RANGE Switch	1 VOLT
FUNCTION Switch	VOLTS INPUT R-2M

Check meter zero. If necessary, adjust with the meter mechanical zero.

- c. Connect the power cord and set the METER Switch to +. Within one minute, the meter needle should be at zero with the input shorted. If the meter is not exactly at zero with the input shorted after approximately 20 minutes, adjust the internal BIAS ADJ Potentiometer, R125 for exact meter zero. (See paragraph 5-5.) For maximum accuracy, allow the Model 153 to warm up approximately 30 minutes.

- d. To cancel any zero offset, short the input high to low and reduce meter sensitivity. Adjust the front panel ZERO Control.

2-4. VOLTAGE MEASUREMENTS.

- a. Voltage measurements can be made with either of two input resistances: 2 megohms for all ranges, or a higher resistance, from 20 megohms to 200 megohms depending upon the range.

1. Generally, it is better to use the higher input resistance (obtained by setting the FUNCTION Switch to VOLTS OPEN). To maintain the accuracy of measurements, the input resistance should be 100 times the source resistance. (See Table 1-1 for input resistance by ranges.

2. With the higher input resistance, some meter deflection may occur with the input open due to extraneous signal pickup. To reduce this pickup and also to speed recovery from input overloads when measuring low impedance sources, use the 2-megohm input resistance (obtained by setting the FUNCTION Switch to VOLTS (R-2M)).

- b. Connect the voltage source to the INPUT Receptacle. Use properly shielded and grounded leads. Refer to paragraphs 2-8 and following for suggestions and cautions.

- c. Set the RANGE Switch to the highest voltage range. Turn the METER Switch to CENTER ZERO for the correct polarity for the input signal. Increase the Model 153 sensitivity until the meter shows the greatest on-scale deflection. On the 3-volt and higher ranges, the Model 153 will withstand overloads to 1000 volts without damage. On the lower ranges, momentary overloads to 1000 volts will cause only temporary instability and zero offset. Prolonged overloads will damage components and cause increased noise and slower response speeds.

TABLE 1. Model 153 Voltage Input Resistances and Current Input Resistance, Voltage Drop and Maximum Current Overload by Ranges. Maximum Current Overload is the greatest current for the range which will not damage the range resistor.

Voltage Range	Input Resistance With FUNCTION Switch set to		Current Range	Input Resistance	Voltage Drop	Maximum Current Overload (milliamperes)
	OPEN	R-2M				
10 microvolts	~20 M Ω	~1.8 M Ω	10 picoamps	1 M Ω	10 μ v	0.5
30 microvolts	~50 M Ω	~1.9 M Ω	30 picoamps	1 M Ω	30 μ v	0.5
100 microvolts	~200 M Ω	~2 M Ω	100 picoamps	1 M Ω	100 μ v	0.5
300 microvolts	~200 M Ω	~2 M Ω	300 picoamps	1 M Ω	300 μ v	0.5
1 millivolt	~200 M Ω	~2 M Ω	1 nanoamp	1 M Ω	1 mv	0.5
3 millivolts	~200 M Ω	~2 M Ω	3 nanoamps	1 M Ω	3 mv	0.5
10 millivolts	~200 M Ω	~2 M Ω	10 nanoamps	1 M Ω	10 mv	0.5
30 millivolts	~200 M Ω	~2 M Ω	30 nanoamps	100 k Ω	3 mv	1.6
100 millivolts	~200 M Ω	~2 M Ω	100 nanoamps	100 k Ω	10 mv	1.6
300 millivolts	~200 M Ω	~2 M Ω	300 nanoamps	10 k Ω	3 mv	5
1 volt	~200 M Ω	~2 M Ω	1 microamp	10 k Ω	10 mv	5
3 volts	200 M Ω	~2 M Ω	3 microamps	1 k Ω	3 mv	16
10 volts	200 M Ω	~2 M Ω	10 microamps	1 k Ω	10 mv	16
30 volts	200 M Ω	~2 M Ω	30 microamps	100 Ω	3 mv	50
100 volts	200 M Ω	~2 M Ω	100 microamps	100 Ω	10 mv	50
300 volts	200 M Ω	~2 M Ω	300 microamps	10 Ω	3 mv	160
1000 volts	200 M Ω	~2 M Ω	1 milliamp	10 Ω	10 mv	160
			3 milliamps	~1 Ω	3 mv	500
			10 milliamps	~1 Ω	10 mv	500
			30 milliamps	~1 Ω	30 mv	500
			100 milliamps	~1 Ω	100 mv	500

2-5. CURRENT MEASUREMENTS. Set the FUNCTION Switch to AMPS. Select the range using the RANGE Switch. Make sure low resistance leads are used to connect the source to the Model 153 input to minimize input voltage drop. Refer to Table 1 for the voltage drop by ranges and for the maximum allowable current overload which will not damage the instrument. On all ranges momentary overloads will only cause temporary zero offset and instability. Prolonged overloads exceeding the values in Table 1 may damage the current-sensing resistors.

2-6. FLOATING OPERATION.

a. The Model 153 can be connected between two potentials, neither of which is at power line ground. It can be floated up to ± 500 volts off ground. Triaxial connectors are especially useful when operating the low terminal at a different potential from the ground terminal.

b. For best results with floating operation, follow the steps below:

1. Remove the shorting link from the LO or GND Post on the rear panel.
2. Connect the unknown source to the Model 153, connecting the lowest impedance point to the input low. Operate as described in paragraph 2-4. Do not ground any recorders used with this operation, since the low of the Model 153 output is no longer grounded.
3. Use triaxial cable and connectors for floating operation. A complete outer shield protects the operator.
4. Make sure the chassis is grounded. Use the G Post on the rear panel or the ground pin of the power cord.

2-7. RECORDER OUTPUT.

a. Model 153 output for full-scale meter deflection on any range is adjustable from 0 to ± 1.05 volts at up to 1 milliamperes. Output polarity is positive. Output resistance is less than 10 ohms with the DC OUTPUT ADJ Control set for maximum output; resistance varies with the Control setting to 7.5 kilohms maximum. If the Model 153 is used for floating measurements, do not ground the recorder connected to the output.

b. When recording with the Model 153 use the Keithley Model 370 Recorder. The output of the Model 153 is sufficient to drive the Model 370 without the use of any recorder preamplifiers. The Model 370 allows maximum capability of the Model 153. It has 1% linearity, 10 chart speeds and can float up to ± 500 volts off ground. Using the Model 370 with the Model 153 avoids interface problems which may be encountered between a measuring instrument and a recorder.

c. To use the Model 370 with the Model 153 connect the high and low binding posts on the Model 153 rear panel to the same posts on the Model 370. Do not ground the Model 370 if differential measurements are being made. Adjust the easily accessible Calibration Control on the Model 370 for full-scale recorder deflection.

2-8. INPUT CONNECTIONS.

a. The Model 153 INPUT Receptacle is a triaxial type; its mating connector is the Keithley Model 1533. For input leads to the Model 153, Keithley Instruments, Inc., has the Model 1534 Special Low-Thermal Triax Cable which can be connected directly to the Model 1533 Connector. The Connector is made to accommodate the 0.145-inch outer diameter of the Cable.

b. For best connections to the input, use the accessory probes and leads described in Section 7. This will enable the Model 153 to be used under the best conditions. Other considerations for making sure the Model 153 is properly connected are listed in the following paragraphs.

c. Carefully shield the input connection and the source being measured. Unless the shielding is thorough, any alteration in the electrostatic field near the input circuitry will cause definite meter disturbances.

d. Use high resistance, low-noise materials — such as Teflon (recommended), polyethylene or polystyrene — for insulation. The insulation leakage resistance of leads should be greater than 500 megohms to maintain the Model 153 input resistance. Excessive leakage reduces the accuracy of readings from high impedance sources. Voltage breakdown of the cable must also be high: 1000 volts center conductor to inner shield; 500 volts between shields. The Model 1534 Cable meets these requirements. Triaxial cables used should be a low-noise type which employ a graphite or other conductive coating between the dielectric and the surrounding shield braid.

e. Any change in the capacitance of the measuring circuit to ground will cause extraneous disturbances. For instance, cable flexure changes the cable capacitance and thus affects meter readings. Make the measuring setup as rigid as possible and tie down connecting cables to prevent their movement. If a continuous vibration is present, it may appear at the output as a sinusoidal signal and other precautions may be necessary to isolate the instrument and the connecting cable from the vibration.

f. For low impedance measurements, unshielded leads and the Model 6012 Adapter may be used. Since the circuit low and ground are connected with the Adapter, do not use it for off-ground measurements.

NOTE

Keithley Instruments, Inc., has several booklets available on low voltage measurements and low current high resistance measurements. A list is available from Keithley Instruments, Inc., or its representative.

2-9. ACCURACY CONSIDERATIONS. For sensitive measurements — 100 millivolts and below — other considerations besides the instrument affect accuracy. Effects not noticeable when working with higher voltages are very important with microvolt signals. The Model 153 only reads the signal received at its input; therefore, it is important that this signal be properly transmitted from the source. The following paragraphs indicate factors which affect accuracy: thermal emf's, shielding and circuit connections.

2-10. THERMAL EMF'S.

a. Thermal emf's (thermo-electric potentials) are generated by thermal gradients between any two junctions of dissimilar metals. These can be significant compared to the signals which the Model 153 can measure.

b. Thermal emf's can cause the following problems:

1. Metal instability or zero offset much higher than normal. Note, though, the Model 153 may have some offset (paragraph 2-3).

2. Meter is very sensitive to ambient temperature variations. This is seen by touching the circuit, by putting a heat source near the circuit, or by a regular pattern of instability, corresponding to heating and air conditioning systems or changes in sunlight.

c. To minimize the drift caused by thermal emf's, use the same metal or metals having low thermo-electric powers in the input circuit. Gold, silver and low-thermal solder have thermo-electric powers within about $\pm 0.25 \mu\text{V}/^\circ\text{C}$ of copper. This means even a temperature difference of 10°C between one of these metals and copper will generate a thermal emf of 2.5 microvolts. At the other extreme, germanium has a thermo-electric power of about $320 \mu\text{V}/^\circ\text{C}$, and silicon will develop about $420 \mu\text{V}/^\circ\text{C}$ against copper. Standard physical handbooks contain tables of thermo-electric powers of materials. Since the Model 153 input circuit is of copper, the best junction is copper to copper. However, copper oxide in the junction or differences in processing of two pieces of copper can cause thermal emf's of up to 0.2 microvolt per $^\circ\text{C}$. The Model 1483 Kit contains all necessary equipment to make very low-thermal joints. See Section 7.

d. Maintaining constant temperatures also reduces thermal emf's. For low voltage measurements, keep all circuits from open windows, fans, air conditioning vents and similar sources which vary temperature. Minimize thermal gradients by placing all junctions physically close on a large heat sink. Thoroughly clean all copper leads with a non-metallic abrasive such as Scotch Brite before making a connection. Crimp together the ends of each copper wire; bolt the lugs for each connection point together; mount all stacks of lugs on a thick metal plate having high thermal conductivity. Thermal conductivity between the junctions and the heat sink can be kept at a high level by using mica washers or high conductivity ceramics for electrical insulation.

e. Several other techniques will reduce the effects of thermal emf's. Use only cadmium-tin low-thermal solder (Model 1503), such as supplied in the Model 1483 Kit, for soldered connections. Unlike metals — including regular solder — may be used and low thermal emf's obtained if a well-controlled oil bath or a good heat sink is used. Thermal voltages may be calculated from the thermoelectric power of the materials in the junction and the temperature difference between the junctions.

2-11. SHIELDING.

a. Generally, the Model 153 is insensitive to ac voltages superimposed upon a dc signal at the input terminals. However, ac voltages which are very large compared with the dc signal can cause erroneous readings. Usually it is sufficient to connect the cases of all apparatus in the measurement circuit together and ground at one point. This provides a "tree" configuration, which minimize ground loops. Also floating the instrument (paragraph 2-6) will minimize ground loops. The common point at which all shields are connected should be as near as possible to the circuit low of the Model 153 at its input.

b. Improper shielding can cause the Model 153 to react in one or more of the following ways:

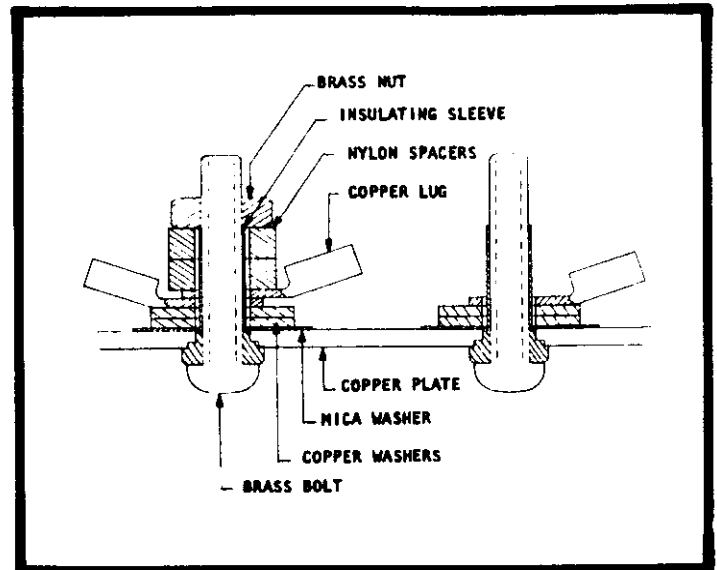

FIGURE 4. Thermal Sink Construction. Connect leads or lugs as close as possible. Separate only with insulation of high heat conductivity.

1. Meter jitter or instability, from 10% to 20% of full scale.
2. High offset (dc bias). Reversing the power cord polarity or removing the connection between the LO and GND Posts may affect the amount of offset.
3. Slow response time, sluggish action and/or inconsistent reading between ranges.
 - c. To minimize pickup, keep the circuit away from ac sources. Shield as carefully as possible. Connect all shields together at the low side of the input or at the LO Post. The voltage induced due to a magnetic flux is proportional to the area of the loop. Therefore, minimize loop areas in the shield connections as well as the input circuitry. Connect the shield at only one point. Run all wires in the circuit along the same path, so the loop area is only the small difference in position of two adjacent wires.
 - d. To reduce the effect of magnetic fields, use magnetic shielding. Where high ac magnetic fields are present, it may be necessary to magnetically shield the measuring circuit, the unknown emf circuit or auxiliary equipment in the circuit. Magnetic shielding is available from several companies in the form of plates, foil or cable.
 - e. The Model 153 line frequency rejection refers to the total ac voltage appearing at the input terminals. Therefore, in null detector applications, it is affected by the sum of the ripple in the working standard and the unknown source. Because of this, working standards having high ac ripple components will significantly reduce the amount of ac voltage which may be tolerated in the unknown.

2-12. CIRCUIT CONNECTIONS.

a. When measuring in the microvolt region, consider the effect the physical connections will have on the potential being measured. Voltage drops, which in most circuits are insignificant, now become important. For example No. 20 AWG copper wire has a resistance of approximately 10 milliohms per foot. A 1-milliampere current through a 6-inch length of this wire will cause a voltage drop of five microvolts. To reduce this drop below 1 microvolt would mean using a wire an inch long.

b. Four-terminal connections can often be used to eliminate this error. Refer to Figure 5.

c. If a small unwanted voltage drop is constant, the ZERO Control may be used to nullify the voltage.

d. If the currents or resistances in the measuring system fluctuate, they will develop fluctuating voltages which will appear as noise or drift in the system.

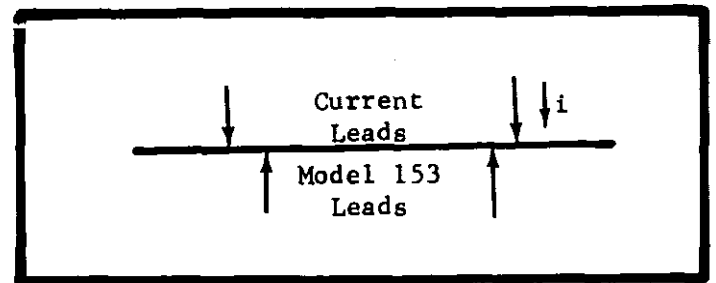

FIGURE 5. Using Model 153 with 4-Terminal Connections.

2-13. OPERATING FROM SOURCE OTHER THAN 117 VOLT. If the ac power source is 234 volts, use a screwdriver to change the 117-234 Switch on the back panel (Figure 3). Change the fuse from 0.5 ampere to 0.25 ampere. No other adjustment is necessary.

SECTION 3. APPLICATIONS

3-1. GENERAL. This Section contains descriptions and diagrams of some Model 153 applications. These are just samples, and they do not exhaust all possible uses. Refer to these applications as demonstrations of techniques for using the Model 153.

3-2. NULL DETECTOR.

a. The Model 153 is ideal for most null detector applications. It is particularly useful for measuring small signals from high source resistances. For instance, the Model 153 can accurately measure a 10-millivolt signal through a 1-megohm source.

b. Figure 6 shows a typical null circuit using the Leeds and Northrup K3 potentiometer. The Model 153 is connected between the unknown and the potentiometer rather than across the null detector terminals because shunts in the potentiometer reduce power sensitivity.

3-3. AMMETER. Solid-state circuit design often requires an ammeter with an extremely wide range. For example, in the circuit of Figure 7, gate current is about 10^{-11} ampere, drain current about 10^{-4} ampere, base current about 3×10^{-6} ampere, and emitter current about 10^{-3} ampere. The Model 153 measures these currents easily and accurately. The low voltage circuitry is undisturbed because the Model 153 has a very low input voltage drop.

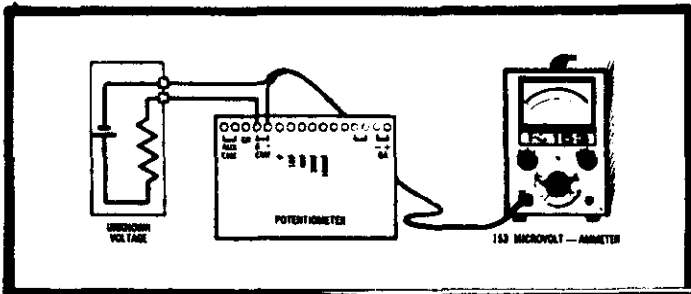

FIGURE 6. Null Circuit Using Model 153 and Leeds and Northrup K3 Potentiometer.

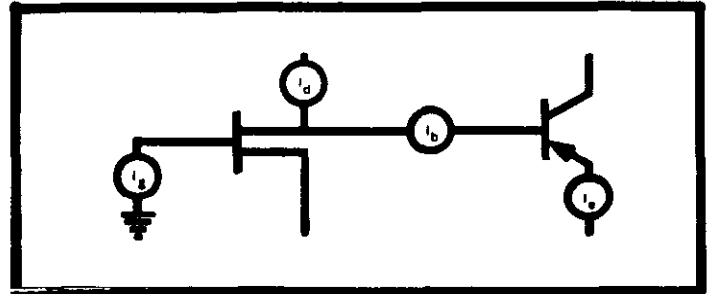

FIGURE 7. Diagram Showing Currents in Solid State Circuits.

3-4. VOLTMETER. Measuring microvolts through megohm source resistance — a prime requisite in semiconductor resistivity measurements — is a simple task for the Model 153. Figure 8 illustrates a typical 4-point semiconductor resistivity measuring system. Four sharp probes contact the surface of a semiconductor wafer or ingot. Known current is applied through the outer two probes, while the inner two pick up the voltage drop. Resistivity is then computed from current, voltage drop and spacing between probes.

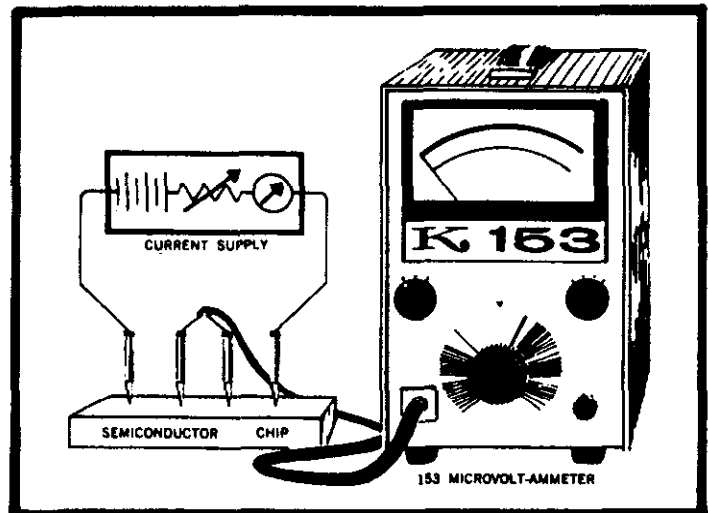

FIGURE 8. Circuit Using Model 153 for Semiconductor Resistivity Measurements.

SECTION 4. CIRCUIT DESCRIPTION

4-1. GENERAL.

a. The Keithley Model 153 Microvolt-Ammeter consists of a photo-modulator, ac amplifier, and demodulator system followed by a dc cathode follower. Feedback is applied to the whole loop.

b. Signals below 1 volt are applied directly to the input filter; those above 1 volt are attenuated 1000:1 with a resistive divider. All signals pass through the low-pass input filter which attenuates undesirable ac signals. The filter has a 3 db cutoff at 4 cps. The filtered dc signal enters the photo-modulator, where it is compared to the feedback voltage. The difference or error signal is modulated at 40 cps, amplified by the tuned ac amplifier, and synchronously demodulated to regain dc. The demodulated signal is filtered and used to drive the output, meter and feedback.

c. The Model 153 operates as an ammeter by measuring the voltage drop across a resistor through which the input current flows. The resistor used and the instrument voltage range determines the current sensitivity.

NOTE

Circuit designations refer to schematic diagram 17771H.

4-2. INPUT CIRCUIT.

a. The setting of the FUNCTION Switch, S2, determines the input resistance of the Model 153. With the Switch set to VOLTS INPUT R-2M, resistor R133 is connected to the high input terminal, and the input resistance is approximately two megohms for all ranges. Setting the Switch to OPEN increases the input resistance of each range to that shown in Table 1. For the 3-volt and higher ranges, the input resistance is 200 megohms, as determined by resistors R134 and R135. For the lower ranges the input resistance is not a fixed resistance, but a synthetic resistance obtained by using high feedback factors.

b. For the 3-volt and higher ranges, the input signal is attenuated 1000:1 by a resistive divider, consisting of resistors R134 to R137.

c. The input signal is then filtered by the low pass input filter to remove unwanted ac signals from the voltage being measured. The filter consists of resistors R102, R103 and R104 and capacitors C101, C102 and C103.

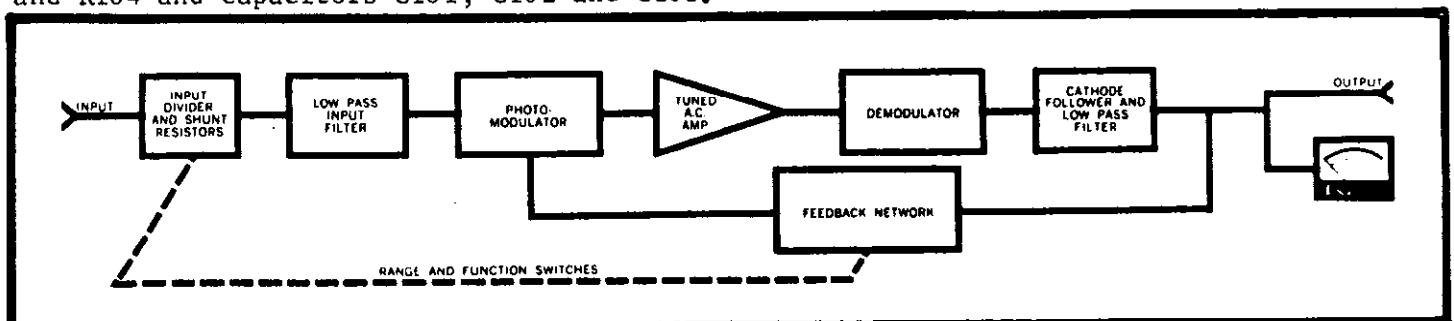

FIGURE 9. Model 153 Block Diagram.

d. Resistor R102 and neon lamp GL101 in the input circuit provide overload protection for the voltmeter. The input also includes a system for increasing the speed of measurements from high source impedances by driving capacitor C102 from the feedback signal.

e. The dc input signal is converted to an ac signal by photo-modulators E101 and E102. The photo-modulators are specially designed for high input resistance and low offset. Lucite rods are used to conduct the light from lamps E101B and E102B to the cells to reduce the drive signal through them.

f. The input filter and photo-modulator are housed in a separate compartment to shield and insulate these circuits.

4-3. AMPLIFIERS.

a. The ac signal from the photo-modulator is amplified by a 5-stage ac amplifier and demodulated to dc.

b. The ac amplifier uses low-noise design with fixed bias and low plate voltage on the first two amplifier stages, V101A and V102A. The fourth amplifier stage uses a frequency selective twin-T filter tuned to the carrier frequency to reduce noise and to reduce the modulation products and beats associated with the modulating action. Resistors R145 to R153 are selected with the RANGE Switch and are used in the circuit to vary the amplifier gain as the ranges are changed. This maintains an approximately constant feedback factor on all but the most sensitive ranges.

c. The output of the ac amplifier is applied to photo-modulator E103 and converted to dc. The signal is filtered by capacitor C120 and resistors R126 and R128 to R130 to reduce the carrier signal appearing on the output.

4-4. CATHODE FOLLOWER. The filtered dc signal is applied to the cathode follower, tube V103B, an impedance transformer which provides a 1-volt, 1-milliampere output. The output also supplies the recorder output, meter and feedback network.

4-5. FEEDBACK NETWORK.

a. The feedback network, constructed of accurate stable resistors, controls the input sensitivity of the instrument. Special precautions have been taken to keep any thermal emf's generated to a minimum.

b. The feedback network is connected between the output of tube V103B and the photo-modulator, E102A. Setting the RANGE Switch, S1, selects the feedback resistor, R131, R158 and R164 to R173, used for the particular range.

4-6. AMMETER OPERATION. When the FUNCTION Switch is set to AMPS, one of resistors R138 to R144 is connected across the input. The particular resistor depends upon the range being used. The voltage drop across the resistor, which varies from 10 microvolts to 100 millivolts, is then measured by the Model 153, and read directly in amperes.

4-7. MULTIVIBRATOR. The multivibrator is a twin-triode tube, V201, which uses highly stable resistors and capacitors in the frequency determining circuits. Potentiometer R210 adjusts the multivibrator frequency to exactly that of the frequency selective amplifier. The multivibrator is used to drive the neon lamps in the photo-modulators.

4-8. POWER SUPPLY. The power supply uses a highly shielded transformer, T1, to obtain good line isolation for floating operation. A separate winding with rectifiers supplies a dc voltage for the first amplifier tube filament to reduce amplifier noise. The power supply output is regulated by tubes V302 and V301 and zener diode D305. There are three regulated outputs, +257, +150 volts and -13 volts. An unregulated -306 volts is also furnished to the multivibrator.

Instrument	Use
Hewlett-Packard Model 200CD Oscillator, 5 cps to 600 kc, $\pm 2\%$	Low frequency rejection
Keithley Instruments Model 241 Regulated High Voltage Supply, 0 to 1000 volts, $\pm 0.05\%$	Source for calibrating high voltage ranges
Keithley Instruments Model 260 Nanovolt Source, 10^{-6} to 10^{-3} volt, $\pm 0.5\%$, 10^{-3} to 1 volt, $\pm 0.25\%$	Source for calibrating low voltage ranges
Keithley Instruments Model 261 Picoampere Source, 10^{-11} to 10^{-7} ampere, $\pm 0.5\%$; 10^{-7} to 10^{-4} ampere, $\pm 0.25\%$	Source for calibrating current ranges
Keithley Instruments Model 370 Recorder	Record stability
Keithley Instruments Model 610B Electrometer	General circuit testing
Tektronix Type 504 Oscilloscope; dc to 450 kc, 5 mv/cm sensitivity	Check wave forms
Tektronix Type P6006 Probe; 10-megohm input impedance, 10:1 attenuation ratio	Use with oscilloscope
22-megohm shielded resistor	Open circuit zero adjustment
200-megohm shielded resistor	Input impedance check
Divider: 22 M Ω and 1 k Ω with 1000 μ f, 15 v coupling capacitor (Figure 13).	Multivibrator frequency adjustment
Grid-modulated tube tester	Test tubes

TABLE 2. Equipment Recommended for Model 153 Troubleshooting and Calibration. Use these instruments or their equivalent.

SECTION 5. SERVICING

5-1. GENERAL. Section 5 contains the maintenance and troubleshooting procedures for the Model 153. Follow these procedures as closely as possible to maintain the accuracy and usefulness of the instrument.

5-2. SERVICING SCHEDULE. The Model 153 needs little periodic maintenance beyond the normal care required of high-quality electronic equipment. No part should need replacement under ordinary use except the bias batteries or, occasionally, a vacuum tube. The life of the bias batteries is approximately two years.

5-3. PARTS REPLACEMENT. The Replaceable Parts List in Section 8 describes the electrical components in the Model 153. Replace components only as necessary; use only reliable replacements which meet the specifications. Replace those items listed for Keithley manufacture (80164) only with components supplied by Keithley Instruments, Inc., or its representative. Tube V101 is aged; replace only with a Keithley part.

5-4. TROUBLESHOOTING.

a. The following procedures are for repairing troubles which might occur in the Model 153. Use these procedures to troubleshoot and use only specified replacement parts. Table 2 lists equipment recommended for troubleshooting. If the trouble cannot be readily located or repaired, contact Keithley Instruments, Inc., or its representative.

b. Before proceeding with the troubleshooting, check the vacuum tubes. Normally, replacing tubes will clear up the difficulty. All tubes can be readily tested on a grid-

Replaced Tube	Check for	Adjustment	Paragraph Reference
V101	noise	replace tube	—
	meter accuracy	meter adjustment	6-3
V102 and V201	slow or sluggish response on 10 and 30- μ v ranges	multivibrator frequency adjustment	5-6
	meter accuracy	meter adjustment	6-3
V103	correct bias	bias adjustment	5-5
	meter accuracy	meter adjustment	6-3
V301 and V302	correct bias	bias adjustment	5-5
	zero center meter accuracy	zero center meter adjustment	6-3

TABLE 3. Possible Adjustments for Replaced Tubes. After a faulty tube is replaced, the above adjustments might be necessary. Refer to paragraph 5-4.

modulated tube tester for usual operation. However, substituting known good tubes is the best way to test a tube. If replacing a tube does not correct the trouble, continue the procedures. Replacing tubes does not necessitate complete recalibration of the instrument. Refer to Table 3 for adjustments which might be necessary.

c. Table 4 contains the more common troubles which might occur. If the repairs indicated in the Table do not clear up the trouble, make a point-by-point check of the circuits. Start by rechecking the power supply for proper operating voltages: +275 volts, +150 volts, and -13 volts. Figures 10 to 12 show typical ripple at three test points within the power supply. Use the Oscilloscope to obtain the patterns.

d. The schematic diagram 17771H, found in Section 8, contains the voltages at selected points. For these values, measured with the Model 610B to $\pm 10\%$, the Model 153 input is shorted. The Model 153 controls are set:

METER Switch	+
FUNCTION Switch	VOLTS R-2M
RANGE Switch	1 VOLT

Refer to the circuit description in Section 4 to find the more crucial components and to determine their function in the circuit.



FIGURE 10. Wave Form at Junction of Diodes D301 and D302 (Figure 27). Vertical setting is 1 volt/cm; horizontal, 2 milliseconds/cm. Output is approximately +400 volts dc.

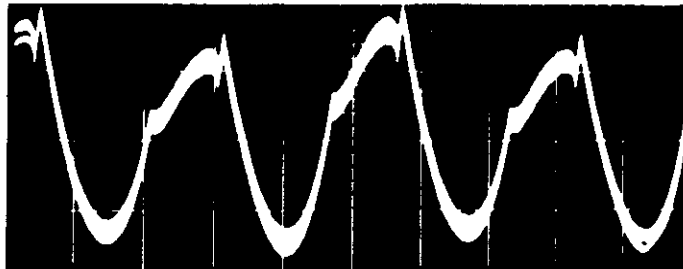

FIGURE 11. Wave Form at Junction of Resistor R302 (Figure 27) and Capacitor C302B (Figure 19). Vertical setting is 5 millivolts/cm; horizontal, 2 milliseconds/cm. Output is approximately +12 volts dc.

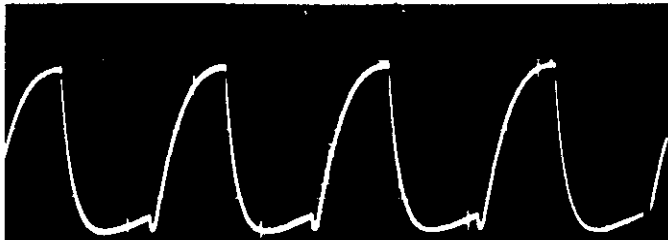

FIGURE 12 (Left). Wave Form at -13 Volt Supply. Vertical setting is 20 millivolts/cm; horizontal, 5 milliseconds/cm.

5-5. BIAS ADJUSTMENT. Check the mechanical meter zero. Short pin 1 of tube V103 to ground by connecting point T. P. (Figure 21) to ground. Set the RANGE Switch to 1 VOLT; the METER Switch to +; and the FUNCTION Switch to INPUT R-2M. Adjust the BIAS ADJ Potentiometer, R125 (Figure 20), for a zero meter reading. Remove the short between T. P. and ground; adjust for exact meter zero.

5-6. MULTIVIBRATOR FREQUENCY ADJUSTMENT.

a. Remove tubes V101 and V103 (Figure 21). Turn the METER Switch to + and the FUNCTION

Difficulty	Probable Cause	Solution
Instrument inaccurate on all ranges	METER CAL Potentiometer R176 out of adjustment	Adjust per paragraph 6-3
Instrument inaccurate on 3-volt and higher ranges	ATTENUATOR Potentiometer R137 out of adjustment	Adjust per paragraph 6-4
Excessive zero drift	Input filter capacitors polarized from excessive overload	Let sit for a few hours on 3 to 100-mv range
	Battery B101 or B102 faulty	Check; replace if faulty
	V101, V102 or V103 faulty	Check; replace if faulty
	Diode D103 faulty	Check; replace if faulty
Slow or sluggish response on all ranges	MULTIVIBRATOR Potentiometer R210 out of adjustment	Adjust per paragraph 5-6
Excessive zero drift and slow sluggish response	MULTIVIBRATOR Potentiometer R210 out of adjustment	Adjust per paragraph 5-6
Excessive noise on most sensitive voltage ranges	Battery B101 or B102 faulty	Check; replace if faulty
	Excessive overload damaged resistor R102	Check; replace if faulty
	Tube V101 or V103 faulty	Check; replace if faulty
	Diode D103 faulty	Check; replace if faulty
Constant offset on all ranges with input shorted	Meter mechanical zero out of adjustment	Set METER Switch to POWER OFF; adjust
	BIAS Potentiometer R125 out of adjustment	Adjust per paragraph 5-5
Meter off zero on zero center scale	ZERO CENTER Potentiometer R177 out of adjustment	Adjust per paragraph 6-3
Zero shift with changing source resistance on more sensitive ranges	OPEN CIRCUIT ZERO Potentiometer R160 out of adjustment	Adjust per paragraph 6-5
Excessive ac line frequency interference	Large ac fields present	Change location or improve shielding
	Battery B101 faulty	Check; replace if faulty
	Heater-to-cathode leakage in V101, V102 or V103	Check; replace if tube is faulty
	Excessive power supply ripple	Check per paragraph 5-4

TABLE 4. Model 153 Troubleshooting Chart.

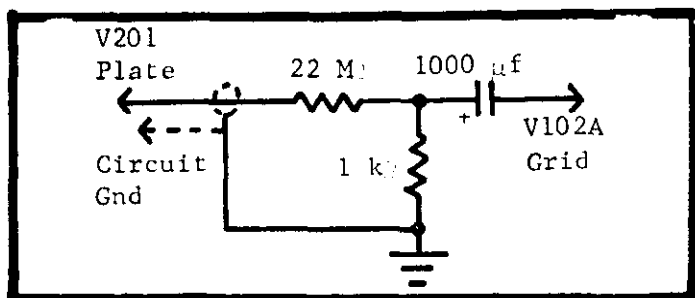

FIGURE 13. Divider Connection for Multivibrator Frequency Adjustment. Connect the divider to either pin 1 or 6 of V201 and to pin 2 of V102A. Use 1%, 1/2 watt, deposited carbon resistors and a 15-volt capacitor for the divider.



FIGURE 14. Wave Form of Multivibrator Output. Oscilloscope was attached to pin 1 of tube V201A (Figure 19). Vertical setting is 100 volts/cm; horizontal, 5 msec/cm.

SWITCH to INPUT R-2M. Use the Model 610B to check pin 7 of tube V101 for approximately -1.23 volts $\pm 10\%$.

b. Place the resistor divider from either plate of tube V201 (Figure 19) to ground. See Figure 13. Connect the output of the divider to the grid of tube V102A (Figure 21). Monitor the output across resistor R121 (Figure 22) with the Type P6006 Probe.

c. Set the RANGE Switch to 30 MILLIVOLTS. Adjust the MULTIVIBRATOR FREQUENCY ADJ Potentiometer, R210 (Figure 27), to obtain the largest signal across resistor R121, approximately 6.5 to 7.5 volts peak-to-peak (650 to 750 millivolts with divider Probe). Figure 14 shows typical wave form at the multivibrator output. Figure 15 shows typical waveform across R121 (junction of R121 and C117). If tuning potentiometer R210 does not cause the signal to swing through maximum, change the value of resistor R208 (Figure 27) to center the potentiometer adjustment.

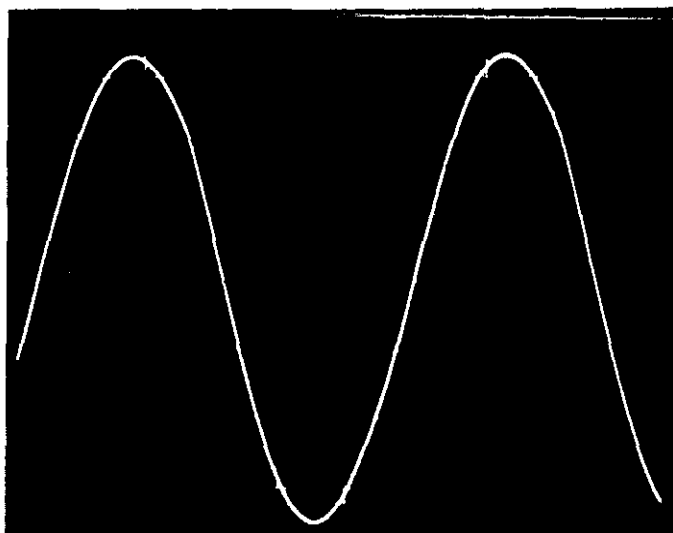

FIGURE 15. Wave Form for Tuned Multivibrator Output Across Resistor R121 (Figure 22). Vertical setting is 1 volt/cm; horizontal, 2 milliseconds/cm.

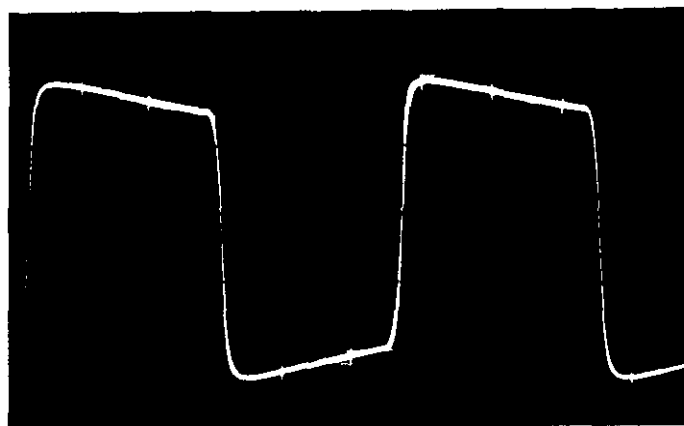

FIGURE 16. Wave Form for Input Modulator E101. The output is monitored at pin 2 of V101 with a 10:1 divider probe. Oscilloscope is dc coupled. Vertical setting is 20 millivolts/cm; horizontal, 2 milliseconds/cm.

Tube	Gain
V101A	10
V101B	10
V102A	20-30
V102B	25-35
V103A	30-35

TABLE 5. Approximate Amplifier Gains by Stages.

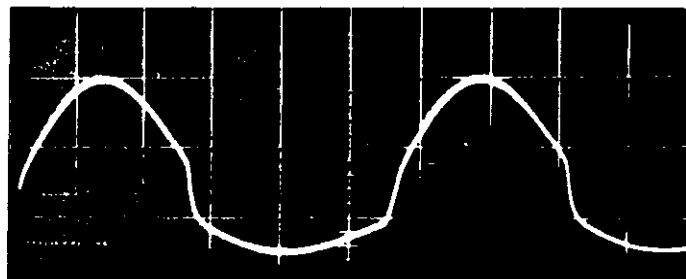

FIGURE 17. Demodulator Wave Form for Full-Scale Input on 1-Volt Range. The signal is monitored at the junctions of capacitor C113, resistor R126 and modulator E103A. Vertical setting is 2 volts/cm; horizontal, 2 milliseconds/cm.

5-7. INPUT MODULATOR CHECK.

a. Remove the divider of Figure 13; remove tube V101 (Figure 21). Short the feedback network to ground; see paragraph 5-8b. Set the RANGE Switch to 1 VOLT. Use the Model 260 Nanovolt Source to apply a +1 volt input signal to the Model 153. Use the Type P6006 Probe with the Oscilloscope to monitor the signal at pin 2 of tube V101 (Figure 21). A typical wave form is shown in Figure 16 for a properly functioning modulator E101 (Figure 23). The wave should be a minimum of 700 millivolts peak-to-peak average value (70 millivolts using the 10:1 Probe).

b. Replace all tubes and shields; allow the instrument to stabilize for a few minutes.

5-8. GAIN ADJUSTMENT.

a. The Model 153 maintains an approximately constant feedback factor by changing the amplifier gain for each range. In the gain adjustment, the feedback network is shorted and the constant gain factors are checked.

b. Short the feedback network on the Model 153 by connecting the rear deck of the RANGE Switch, S1 (Figure 19), to the circuit low terminal of the INPUT Receptacle. Set the METER Switch to +, the FUNCTION Switch to OPEN, and the RANGE Switch to 30 MILLIVOLTS. Apply an input signal to the Model 153, using the Model 260, sufficient to obtain a full-scale meter reading; normally this will be between 300 and 400 microvolts. Set the METER Switch to - and repeat this procedure. Average the value of the two input voltages necessary to drive the meter to full scale. If the average is between 300 and 430 microvolts, the loop gain of the Model 153 amplifier is between 100 and 70. If the average is less than 300 microvolts, add resistor, R110 (Figure 22), to decrease the gain. If the average is greater than 430 microvolts, the gain is too low.

c. If the gain is too low, either the efficiency of modulator E101 (Figure 23) is too low or the gain of a particular amplifier stage is too low. Normally, the modulator efficiency should be greater than 70%. For a 1-volt input signal, the demodulator wave form on the 1-volt range is shown in Figure 17. Typical stage gains are shown in Table 5.

5-9. NOISE. Set the Model 153 RANGE Switch to 10 MICROVOLTS and short its input. Meter noise must be less than 3 minor divisions, exclusive of any thermal drift. Set the FUNCTION Switch to AMPS. Shield the input and check meter noise. It should be less than 5 minor divisions, exclusive of any thermal drift.

5-10. AC REJECTION CHECK.

a. 60-cps Rejection: Operate the Model 153 from a 60-cps power line. Use the Oscillator to apply a 10-volt peak-to-peak, 60-cps signal to the Model 153 input. Set the Model 153 RANGE Switch to 100 MILLIVOLTS, and the METER Switch to ZERO CENTER. Turn down the Oscillator output amplitude and make sure the Model 153 is properly zeroed. There should be less than 0.5% change in the meter needle deflection from no signal to full signal. Disregard any transient swings while applying the signal.

b. 50-cps Rejection: Operate the Model 153 from a 50-cps power line. Follow the instructions given for the 60-cps rejection check in the preceding sub-paragraph.

SECTION 6. CALIBRATION

6-1. GENERAL.

a. The following procedures are recommended for calibrating the Model 153. Use the equipment recommended in Table 2. If proper facilities are not available or if difficulty is encountered, contact Keithley Instruments, Inc., or its representative to arrange for factory calibration.

b. The following procedures are covered: meter and attenuator adjustments, open circuit zero adjustment, verification of voltage and current range calibrations, rise time and drift verifications, and input impedance check.

c. If the Model 153 is not within specifications after the calibration, follow the troubleshooting procedures or contact Keithley Instruments, Inc., or its representative.

6-2. CALIBRATION SCHEDULE. Calibrate the Model 153 yearly. This normally means performing the bias adjustment (paragraph 5-5), meter adjustment (paragraph 6-3), attenuator adjustment (paragraph 6-4), and open-circuit zero adjustment (paragraph 6-5). The other verifications need be done only if desired.

6-3. METER ADJUSTMENT.

a. After a 30-minute warm-up, check the Model 153 for zero reading on the 1-volt range. If necessary, adjust the BIAS ADJ Potentiometer, R125 (Figure 20). See paragraph 5-5.

b. Connect the Model 260 Nanovolt Source to the Model 153 INPUT Receptacle. Set the controls as follows:

METER Switch	+
FUNCTION Switch	INPUT R-2M
RANGE Switch	1 VOLT

Control	Circuit Desig.	Fig. Ref.	Refer to Paragraph
Bias adjust	R125	20	5-5
Attenuator adjust	R137	20	6-4
Open Circuit Zero	R160	20	6-5
Meter Calibration	R176	20	6-3
Center Zero adjust	R177	20	6-3
Multi-vibrator frequency adjust	R210	27	5-6

TABLE 6. Model 153 Internal Controls. The Table lists all internal controls, the figure picturing the location and the paragraph describing the adjustment.

Set the Model 260 to apply +1 volt. The Model 153 meter should read full scale, 1 volt $\pm 0.5\%$. If necessary, adjust the METER CAL Potentiometer, R176 (Figure 20), for a full-scale deflection. This adjusts the meter for all voltage ranges below 1 volt.

c. Using the same settings and input as in the previous step, adjust the OUTPUT ADJ Control on the rear panel for a 1-volt output $\pm 1\%$.

d. Remove the input signal from the Model 153 and short the input terminals. Set the METER Switch to CENTER ZERO; keep the FUNCTION and RANGE Switches as in sub-paragraph b. The meter needle should be at zero on the bottom scale. If necessary, adjust the CENTER ZERO ADJ Potentiometer, R177 (Figure 20) for zero meter deflection on the bottom scale.

6-4. ATTENUATOR ADJUSTMENT. Connect the Model 241 Voltage Supply to the Model 153 INPUT Receptacle. Set the Model 153 controls as follows:

METER Switch	+
FUNCTION Switch	INPUT R-2M
RANGE Switch	10 VOLTS

Set the Model 241 to apply +10 volts. The Model 153 should read full scale, 10 volts $\pm 0.5\%$. If necessary, adjust the ATTENUATOR ADJ Potentiometer, R137 (Figure 20), for a full-scale deflection. This adjusts the meter for all voltage ranges 3 volts and higher.

NOTE

Before making this adjustment, warm up the Model 153 for at least two hours and make sure its drift is within specifications (paragraph 6-9.)

6-5. OPEN CIRCUIT ZERO ADJUSTMENT. Set the Model 153 RANGE Switch to 30 MICROVOLTS. Shunt the input with a 22-megohm shielded resistor between the high (center terminal) and low (inner shield) of the INPUT Receptacle. Set the FUNCTION Switch to AMPS; zero the meter using the front panel ZERO Control. Switch the FUNCTION Switch to OPEN and adjust the OPEN CIRCUIT ZERO Potentiometer, R160 (Figure 20), for a zero meter reading. Return the FUNCTION Switch to AMPS position and recheck for meter zero.

6-6. VERIFICATION OF VOLTAGE CALIBRATION.

a. Calibrate the voltage ranges for a full-scale meter deflection on all ranges, both positive and negative polarity. Calibrate the 10-microvolt to 1-volt ranges before calibrating the higher ranges. Make sure potentiometer R125 is adjusted (paragraph 5-5).

b. For the ranges from 10 microvolts to 1 volt, connect the Model 260 to the Model 153 input. For each range, set the Model 260 for a full-scale input (i. e., 10-microvolt input signal for the 10-microvolt range; 30-microvolt input signal for the 30-microvolt range, etc.). For the 10 and 30-microvolt ranges, the Model 153 should read within $\pm 2.5\%$; for the 100-microvolt to 1-millivolt ranges, within $\pm 1.5\%$; for the 3-millivolt to 1-volt ranges, within $\pm 0.5\%$. On the zero-left scale, 1% is equivalent to one minor division. Check for both positive and negative polarity. If necessary, adjust the METER CAL Potentiometer, R176 (Figure 20), until all ranges meet specifications. If the potentiometer is adjusted for any subsequent range, repeat the calibration for each previous range until all ranges are within the required accuracy.

c. For the ranges from 3 to 1000 volts, connect the Model 241 Voltage Supply to the Model 153 input. For each range, set the Model 241 for a full-scale input. For all these

ranges, the Model 153 should read within $\pm 0.5\%$ of full scale. Check for both positive and negative polarity. If necessary, adjust the ATTENUATOR ADJ Potentiometer, R137 (Figure 20), for the proper range accuracy. If potentiometer R137 is adjusted for any range, repeat the calibration for each range from 3 to 1000 volts until all ranges are within the required accuracy.

6-7. VERIFICATION OF CURRENT RANGE CALIBRATION.

a. Connect the Model 261 Picoampere Source to the Model 153. For each range, set the Model 261 for a full-scale input. The Model 153 should read within $\pm 1.5\%$ for the 3 nanoampere to 100-milliampere ranges; $\pm 2.5\%$ for the 1-nanoampere to 100-picoampere ranges; and $\pm 3.5\%$ for the 30 and 10-picoampere ranges. For the ranges above 10^{-4} , construct a current source; the Model 261 output is not sufficient for the higher ranges.

b. The range resistor in the 3 through 100-milliampere positions, R144, is selected to a +0%, -2% tolerance due to an approximate 1% effect in the lead resistance from the resistor to circuit low.

6-8. RISE TIME VERIFICATION.

a. Connect the Oscilloscope to the Model 153 OUTPUT. Use a step function (turn the Model 260 POLARITY Switch from OFF to + or - as required) to the Model 153 input which will produce 100, 30 or 10-microvolt full-scale readings. The rise time (10% to 90% of full scale) for a full-scale input signal should be less than 1 second on the 100-microvolt range; less than 5 seconds on the 30 and 10-microvolt ranges.

b. Apply the step function for the 1-millivolt and higher ranges. Note the motion of the meter. If the meter shows uneven travel to full scale, increase the value of resistor R127 (Figure 22) to obtain a smooth motion.

6-9. DRIFT VERIFICATION. Make sure the Model 153 cover is on and the input is shorted with a good low thermal short. Connect the Model 153 to the Model 370 Recorder. Turn the METER Switch to +. During the first two hours of warm-up, the drift should be less than 8 microvolts. After two hours, the drift should be within ± 2 microvolts per 24 hours. See Figure 18 for a typical drift run for the Model 153.

6-10. INPUT IMPEDANCE CHECK. Put a 200-megohm shielded resistor in series with the Model 153 input. Set the Model 153 RANGE Switch to 1 VOLTS and the FUNCTION Switch to OPEN. Apply 1 volt to the resistor with the Model 241 Voltage Supply. The Model 153 must read at least 50% of full scale. If it does not, return the instrument to the factory.

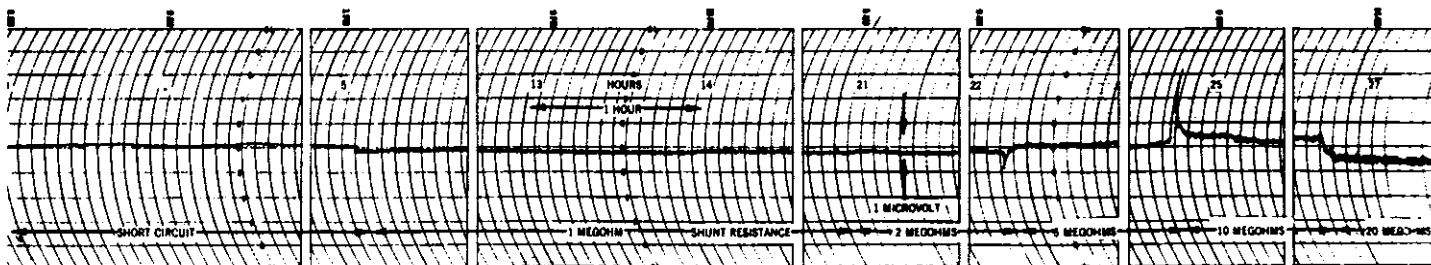

FIGURE 18. Typical Model 153 Drift Chart. The instrument is set on the 10-microvolt range at various increasing input shunt resistances between short circuit and 20 megohms. Noise increases with increase in shunt resistance as Johnson noise in the shunt add in quadrature to basic instrument noise. Transients occurring at points of shunt change are due to physical changing of the shunts.

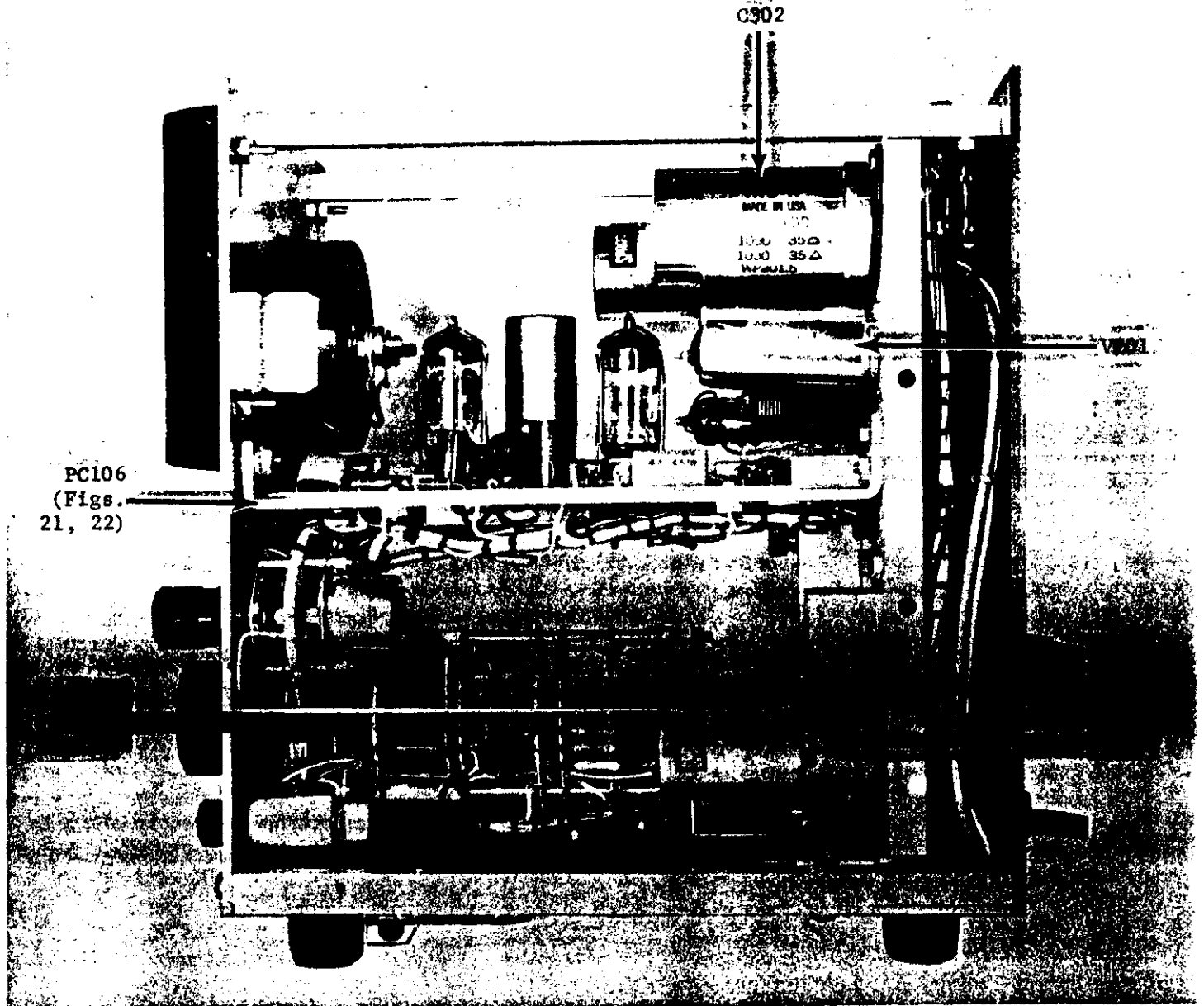

FIGURE 19. Model 153 Interior. Components and assemblies are shown in the view with the meter facing left. Figure 20 shows the chassis view from the other side.

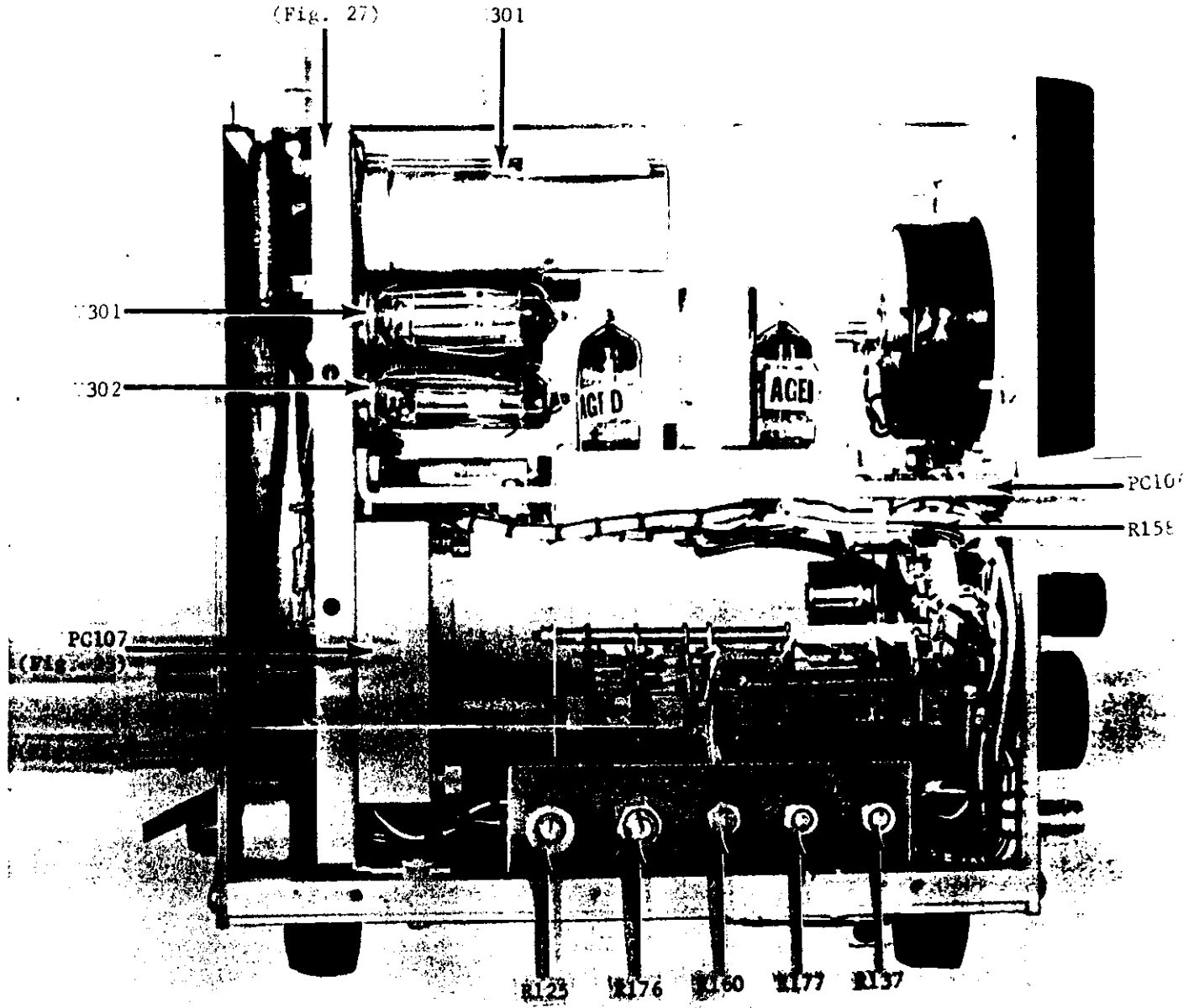

FIGURE 20. Model 153 Interior. Components and assemblies are shown in the view with the meter facing right. Figure 19 shows the chassis view from the other side.

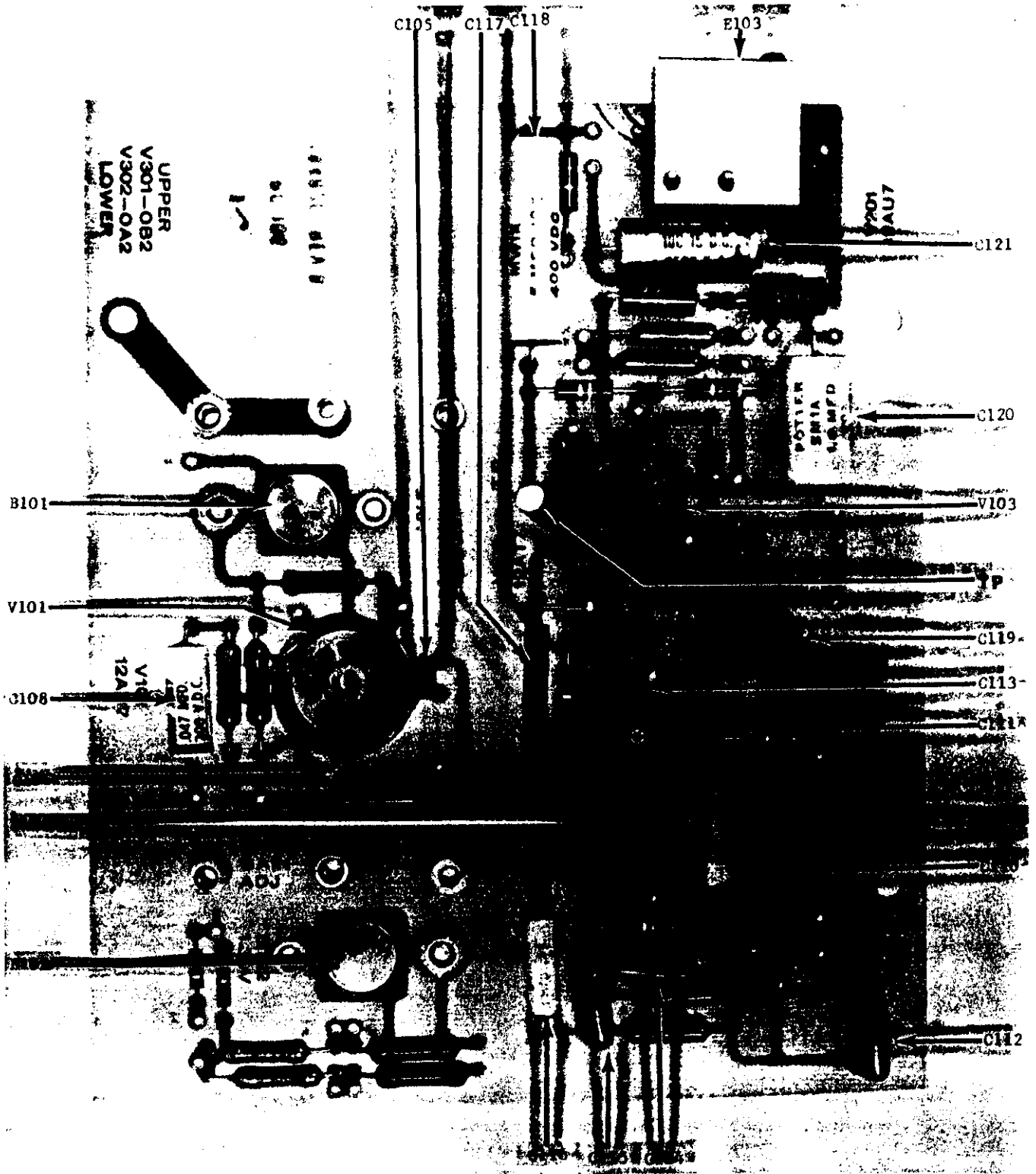

FIGURE 21. Capacitor, Tube, Battery and Modulator Locations on Printed Circuit Board PC106. Refer to Figure 22 for resistor locations.

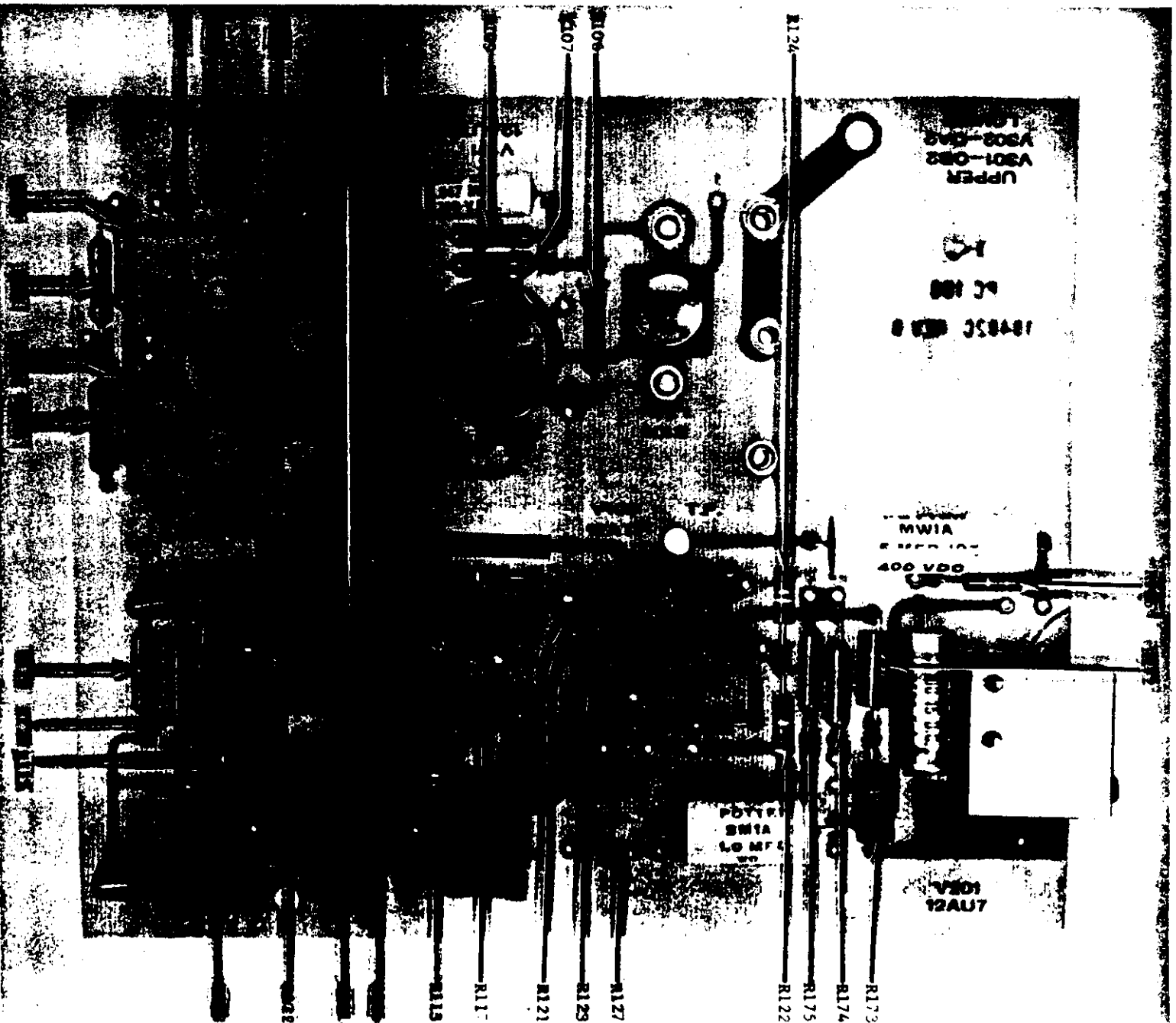

FIGURE 22. Resistor Locations on Printed Circuit Board PC106. Refer to Figure 21 for the location of other components.

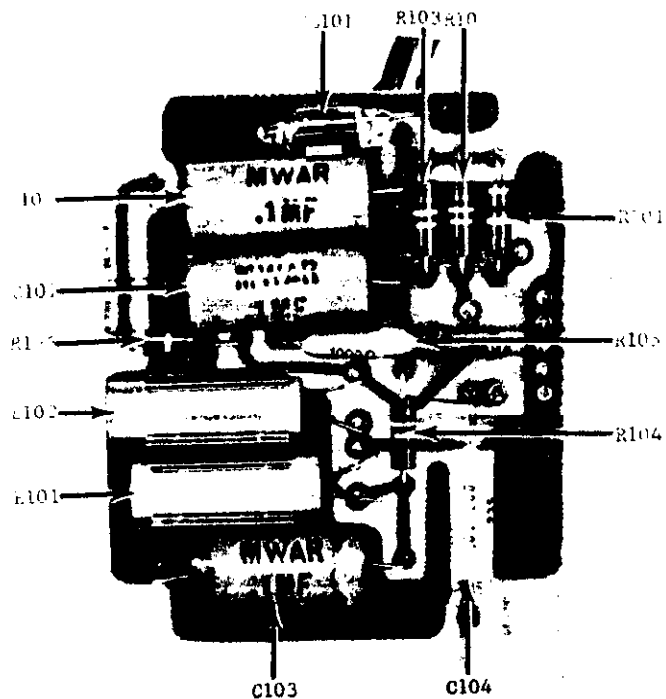
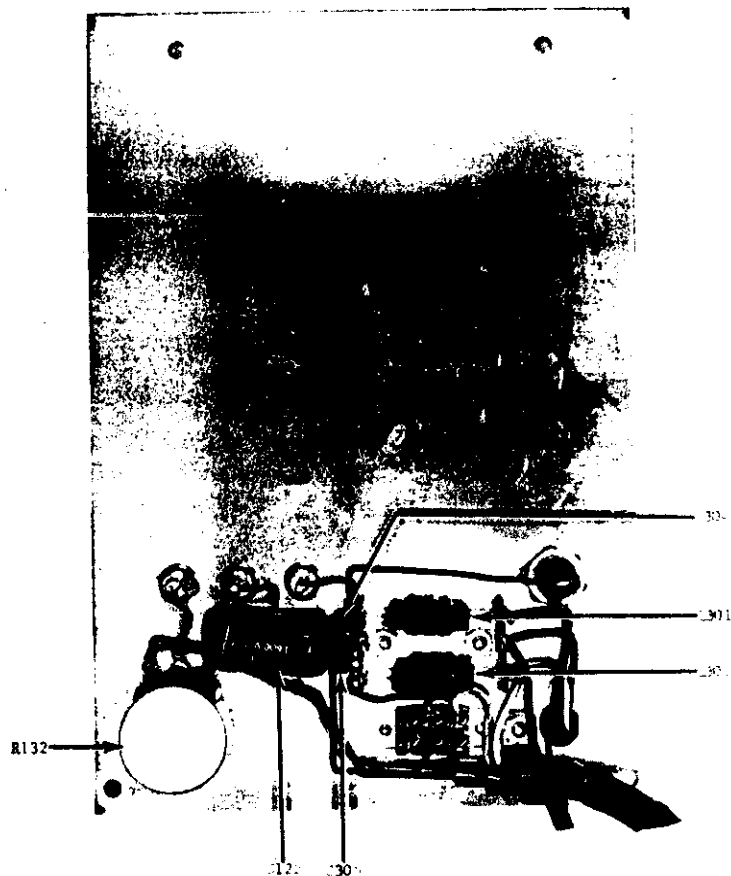

FIGURE 23 (left). Component Locations for Printed Circuit Board PC107.

FIGURE 24 (right). Component Locations on Model 153 Rear Chassis Panel. The view is from the inside of the instrument.



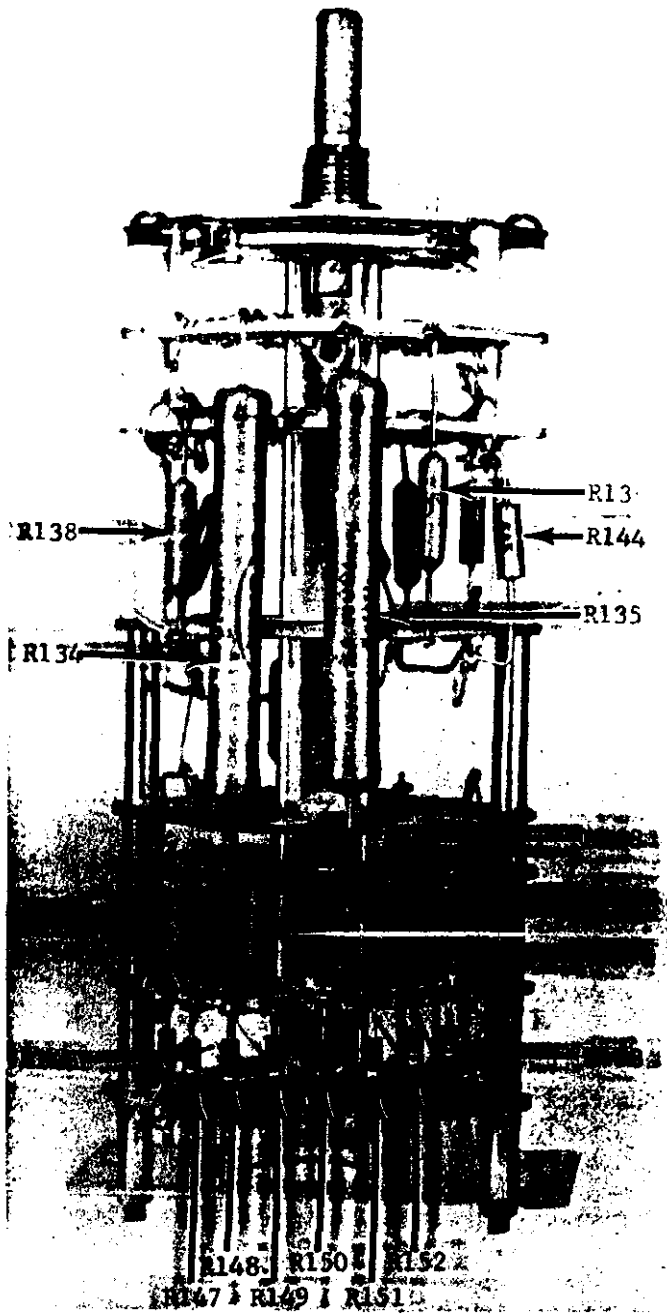

FIGURE 25. Component Locations on Range Switch S1.

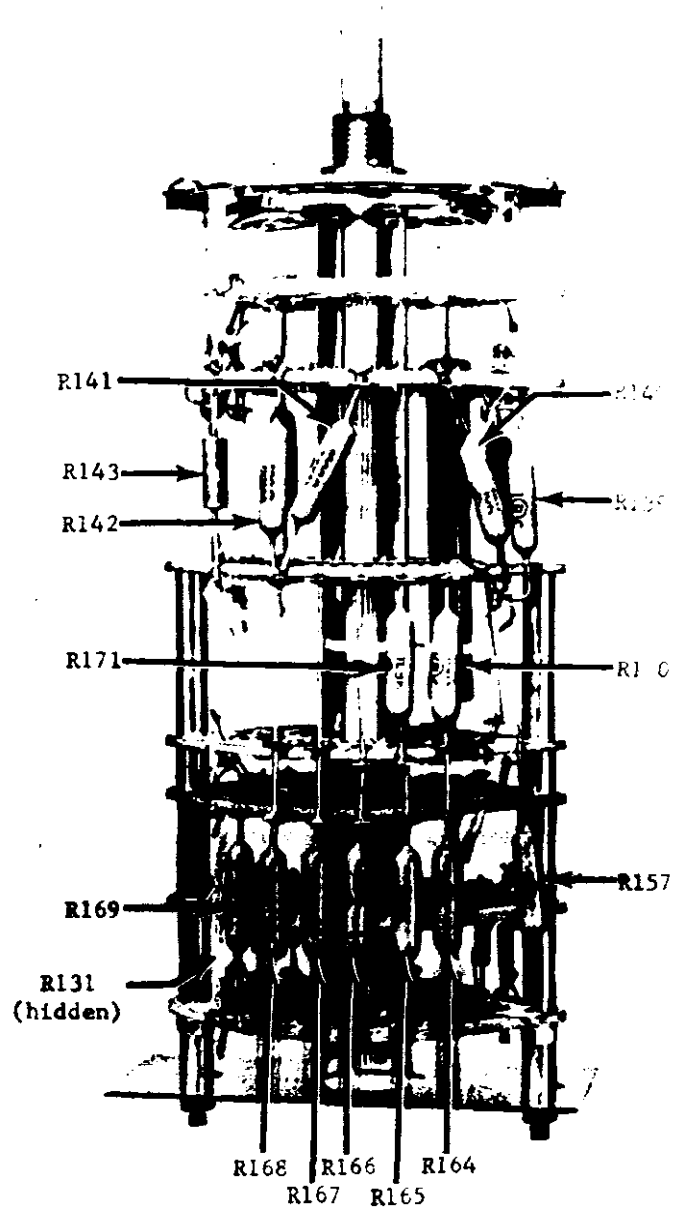

FIGURE 26. Component Locations on Range Switch S1.

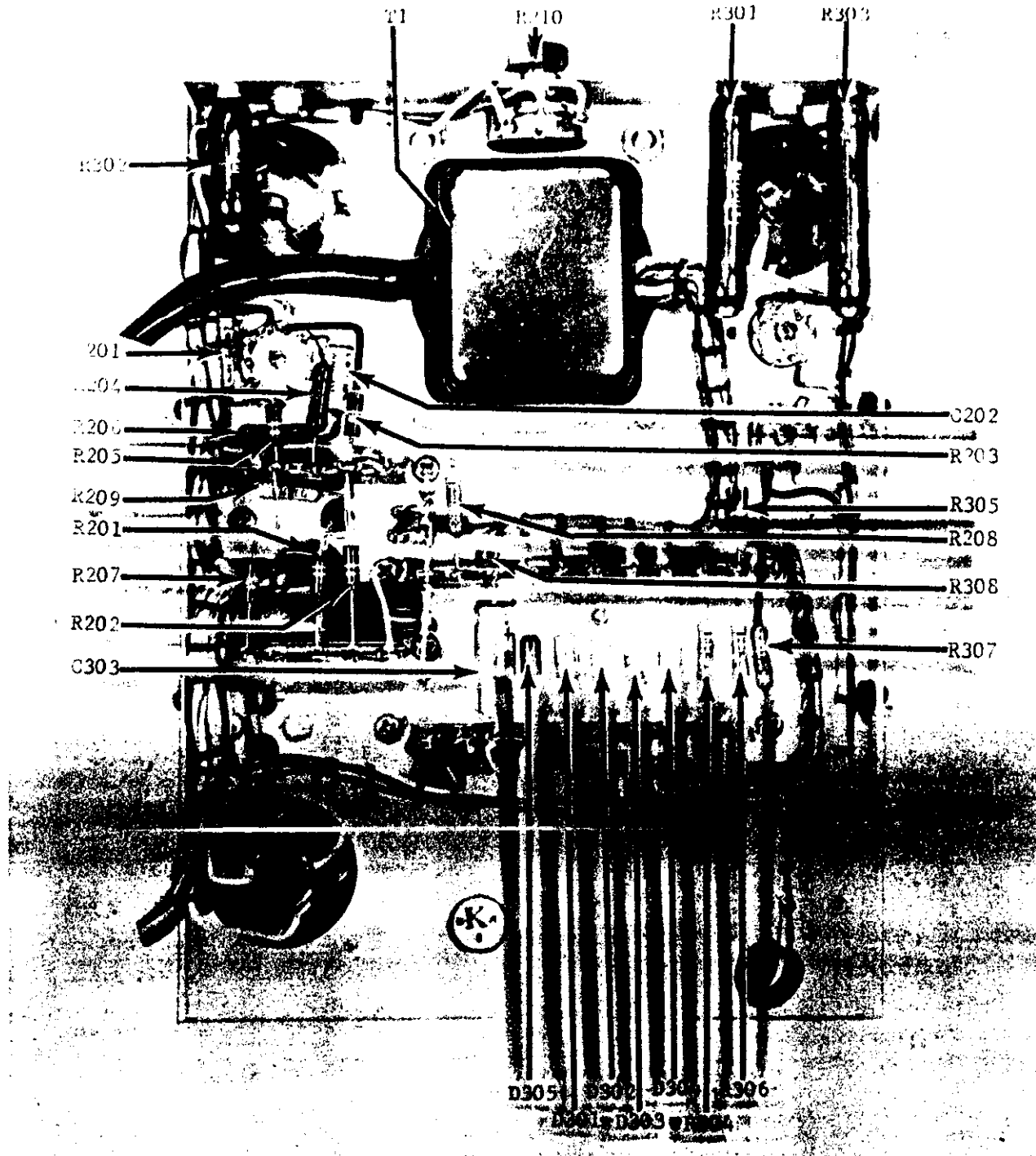

FIGURE 27. Component Locations for Model 153 Power Supply and Multivibrator.

SECTION 7. ACCESSORIES

7-1. MODEL 1531 GRIPPING PROBE (Figure 28). The Model 1531 has a gripping probe and a 3-foot triaxial cable. It is useful for making in-circuit measurements. Its gripping feature is useful for attaching the Probe at a single point for repeated measurements. When making low-level measurements, handle the probe body as little as possible to avoid thermal emf's. Allow the circuit being tested to reach thermal equilibrium before making measurements. Connect the Probe plug directly to the Model 153 INPUT Receptacle. The Keithley part number for the input cable used on the Probe is SC-22; the number for the cable on the low lead is SC-32.

7-2. MODEL 1532 TEST LEADS (Figure 29). An easy way to make connections to the Model 153 is with the Model 1532 Test Leads supplied with the instrument. The Leads consist of a mating connector to the Model 153, a 3-foot cable and two alligator clips. It is designed for repeated measurements. To reduce thermal emf's, the Leads are of all copper construction and use low-thermal cadmium solder connections. For permanent connections, remove the alligator clips and attach the lead to a circuit with low-thermal solder (Model 1503) or by a crimp connection. Clean the bare wire with a non-metallic abrasive, such as Scotch Brite, before making the connection. For crimp connections, use the Model 1483 Kit. The plug on the Leads mates with the Model 153 INPUT Receptacle.

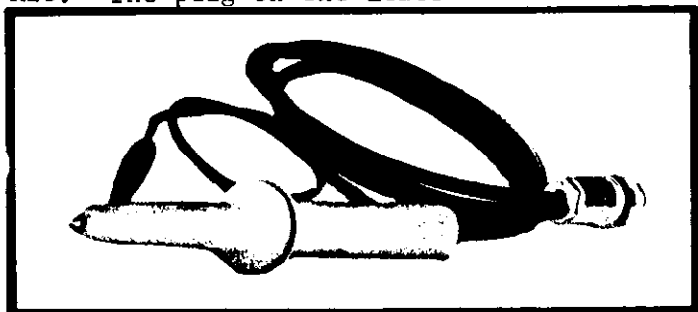

FIGURE 28. Keithley Instruments Model 1531 Gripping Probe.

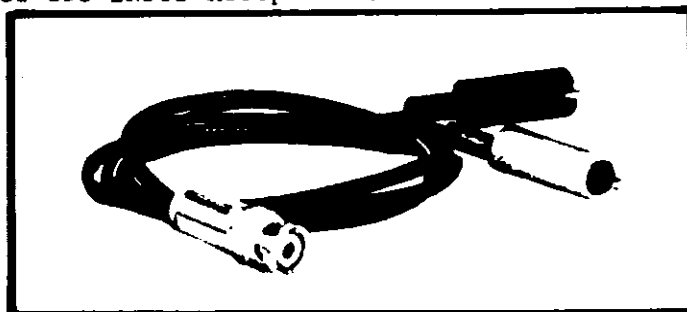

FIGURE 29. Keithley Instruments Model 1532 Test Leads.

7-3. MODEL 1533 MATING CONNECTOR (Figure 30). The Model 1533 is designed to mate with the Model 153 special triaxial INPUT Receptacle and to accept the Model 1534 Triax Cable or any other cable with 0.145-inch outer diameter.

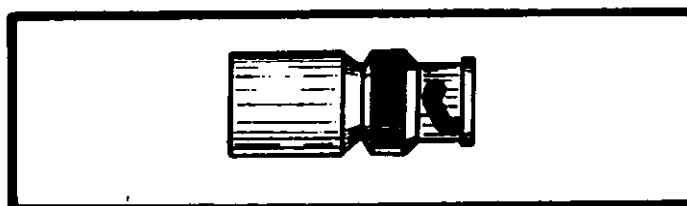

FIGURE 30. Keithley Instruments Model 1533 Mating Connector.

7-4. MODEL 1534 SPECIAL LOW-THERMAL TRIAX CABLE. The Model 1534 is 10 feet of low-noise cable which has leakage resistance sufficiently high to maintain the Model 153's performance specifications. Voltage breakdown is 1000 volts center conductor to inner shield; 500 volts between shields. The Cable uses copper in the signal leads. Outer diameter of the Cable is 0.145 inch. The Cable comes with no connectors.

7-5. ACCESSORY KITS.

a. If cadmium solder (Model 1503) is used for a connection, make sure the soldering iron used is clean and that it has not been used with regular solder before. Use only rosin

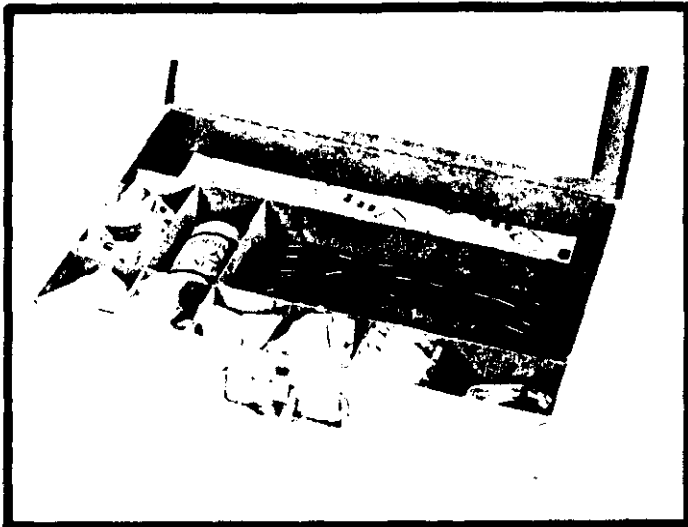

FIGURE 31. Model 1483 Low-Thermal Connection Kit. Refer to Section 8 for contents.

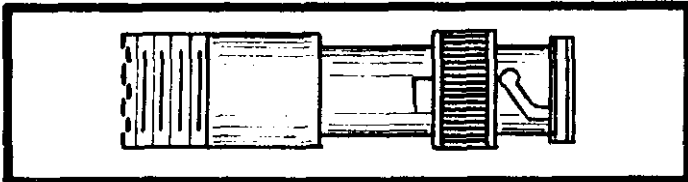

FIGURE 32. Keithley Instruments Model 6012 Triaxial-to-Coaxial Adapter

solder flux. If possible, heat sink all cadmium-soldered joints together to reduce generated thermal emf's. Careful techniques will keep thermal emf's below 0.1 microvolt.

b. Use crimp connections with copper wire and lugs for the best low-thermal joints. Thermal emf's can be reduced to 10 nanovolts or less using the copper wire, sleeves and lugs found in the Model 1483 Low-Thermal Connection Kit. The Kit contains a crimp tool, shielded cable, an assortment of copper lugs, copper wire, cadmium solder and nylon bolts and nuts. It is a complete kit for making very low thermal measuring circuits. The Kit enables the user of the Model 153 to maintain thermal stability in his own circuit. Section 8 lists the contents of the Kit.

7-6. MODEL 6012 ADAPTER (Figure 32). The Model 6012 is a triaxial-to-coaxial adapter. It may be used to connect uhf and coaxial circuits to the Model 153 input. Note, however, that the Model 153 should not be

floated when used with the Adapter. Circuit low and chassis ground are connected, and the outer shell of the Adapter would be off ground if it were floated.

7-7. RACK MOUNTING (See Figure 33).

a. The Model 153 is shipped for bench use. The Model 4005 Rack Mounting Kit converts the instrument to rack mounting to the standard EIA 19-inch width.

b. To convert the Model 153, remove the four screws at the bottom of each side of the instrument case. Lift off the top cover assembly with the handles; save the four screws. To remove the feet and tilt bail from the bottom cover assembly, remove the four screws and allow it to drop off. Remove the feet and tilt bail and replace the bottom cover using the same screws.

Item (See Fig. 33)	Description	Keithley Part No.	Quantity
1	Cover Assembly	20018B	1
2	Mounting Panel	19396B	1
3	Filler Panel	19397B	1
--	Screw, No. 10-3/8, HSS	--	12
--	Kep Nut, No. 10	--	8

TABLE 7. Parts List for Keithley Model 4005 Rack Mounting Kit.

c. Insert the top cover assembly (1) in place and fasten to the chassis with the four screws previously removed. Attach the mounting panel (2) to the rack with four #10 screws and kep nuts. Fasten the Model 153 to the mounting panel with four #10 screws. Fasten the filler panel (3) to the opening in the mounting panel with four #10 screws and kep nuts.

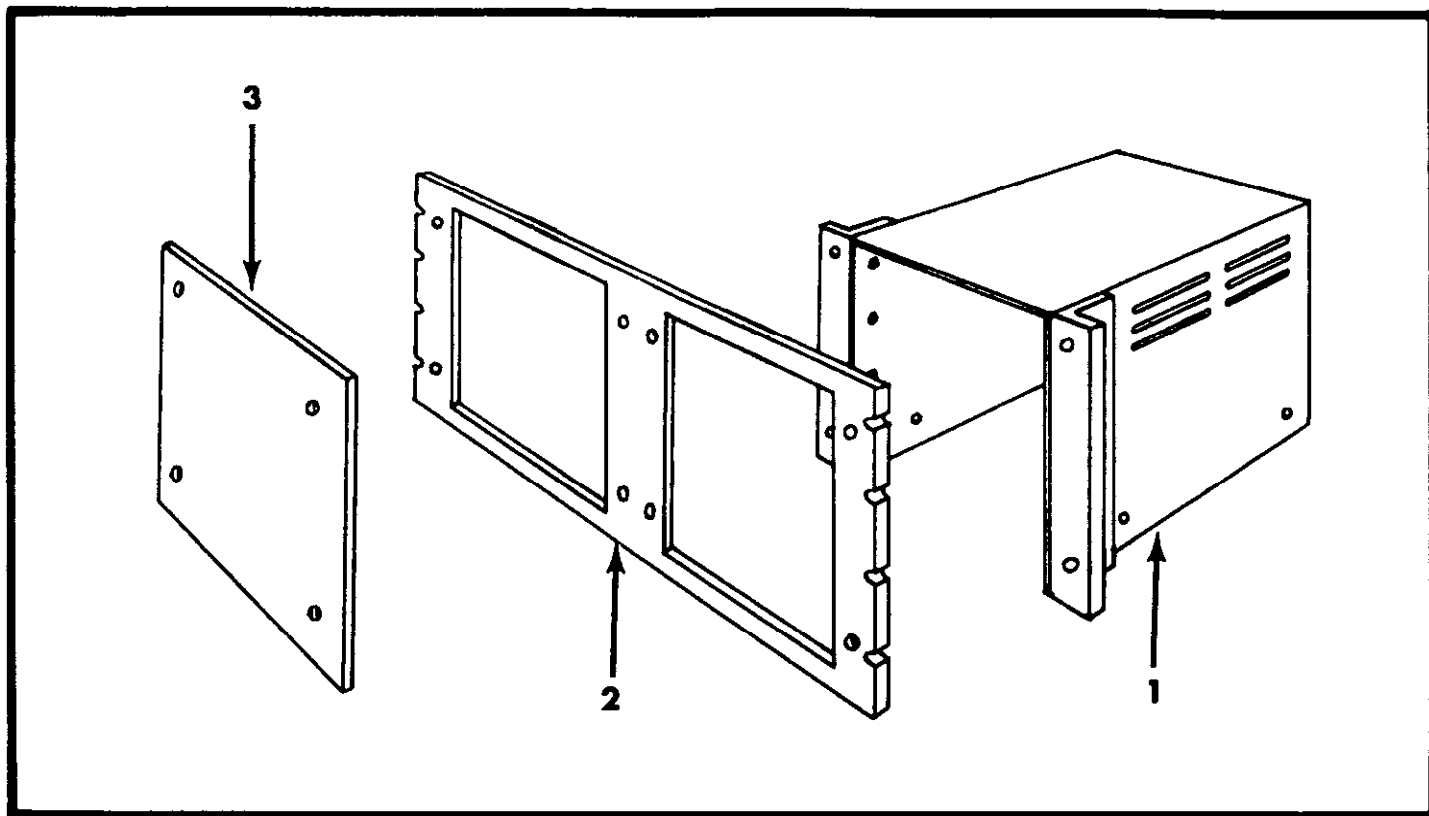

FIGURE 33. Exploded View of Model 4005 Rack Mounting Kit. Refer to Table 7 for parts list.

SECTION 8. REPLACEABLE PARTS

8-1. **REPLACEABLE PARTS LIST.** The Replaceable Parts List describes the components of the Model 153 and its accessories. The List gives the circuit designation, the part description, a suggested manufacturer, the manufacturer's part number and the Keithley Part Number. The last column indicates the figure picturing the part.

8-2. HOW TO ORDER PARTS.

a. For parts orders, include the instrument's model and serial number, the Keithley Part Number, the circuit designation and a description of the part. All structural parts and those parts coded for Keithley manufacture (80164) must be ordered through Keithley Instruments or its representatives. In ordering a part not listed in the Replaceable Parts List, completely describe the part, its function and its location.

b. Order parts through your nearest Keithley representative or the Sales Service Department, Keithley Instruments, Inc.

amp	ampere	Mfg.	Manufacturer
		MtF	Metal Film
CbVar	Carbon Variable	Mil No.	Military Type Number
CerD	Ceramic, Disc	My	Mylar
Comp	Composition		
CompV	Composition Variable	Ω	ohm
DCb	Deposited Carbon	PMP	Metalized paper, phenolic case
		Poly	Polystyrene
EAl	Electrolytic, Aluminum	p	pico (10^{-12})
EMC	Electrolytic, metal cased		
ETB	Electrolytic, tubular	Ref.	Reference
ETT	Electrolytic, tantulum		
		μ	micro (10^{-6})
f	farad		
Fig.	Figure	v	volt
		Var	Variable
hy	henry		
		w	watt
k	kilo (10^3)	WW	Wirewound
		WWenc	Wirewound encapsulated
M or meg	mega (10^6) or megohms	WWVar	Wirewound Variable
m	milli (10^{-3})		

TABLE 8. Abbreviations and Symbols

MODEL 153 REPLACEABLE PARTS LIST

(Refer to Schematic Diagram 17771H for circuit designations.)

CAPACITORS

Circuit Desig.	Value	Rating	Type	Mfg. Code	Mfg. Part No.	Keithley Part No.	Fig. Ref.
C101	0.1 μ f	100 v	Poly	80164		C142-0.1M	23
C102	0.1 μ f	100 v	Poly	80164		C142-0.1M	23
C103	0.1 μ f	100 v	Poly	80164		C142-0.1M	23
C104	.01 μ f	500 v	Poly	71590	CPR-1000J	C138-.01M	23
C105	.001 μ f	1000 v	CerD	72982	801Z5V102P	C22-.001M	21
C106	.01 μ f	200 v	My	14655	WMF-2S1	C66-.01M	21
C107	40/40/20 μ f	450/450/50 v	EMC	56289	TVL3786	C33-40/40/20M	19
C108	.047 μ f	200 v	My	14655	WMF-2S47	C66-.047M	21
C109	10 μ f	15 v	EAL	56289	89D159	C93-10M	21
C110	0.1 μ f	200 v	My	02777	P-12M	C66-0.1M	21
C111	.01 μ f	1000 v	CerD	72982	811Z5V103P	C22-.01M	21
C112	0.1 μ f	100 v	My	12673	32M	C105-0.1M	21
C113	10 μ f	15 v	EAL	56289	89D159	C93-10M	21
C114	.05 μ f	100 v	My	12673	32M	C105-.05M	21
C115	.05 μ f	100 v	My	12673	32M	C105-.05M	21
C116	.1 μ f	200 v	My	02777	P-12M	C66-0.1M	21
C117	.01 μ f	300 v	CerT	13050	MW1A.01 μ F	C61-.01M	21
C118	0.5 μ f	400 v	My	14655	WMF4P5	C114-0.5M	21
C119	100 μ f	25 v	EAL	29309	JC8100258P	C211-100M	21
C120	1.0 μ f	200 v	My	13050	107-21	C66-1.0M	21
C121	100 μ f	15 v	ETB	56289	TE1162	C3-100M	21
C122	.05 μ f	600 v	My	56289	6PS-S50	C62-.05M	24
C201	.01 μ f	400 v	My	14655	WMF4S1	C114-.01M	27
C202	.01 μ f	400 v	My	14655	WMF4S1	C114-.01M	27
C301	80/40 μ f	450/450 v	EMC	56289	2778	C36-80/40M	20
C302	1000/1000 μ f	35 v	ETB	56289	FP C36-1000/1000M		19
C303	100 μ f	15 v	ETB	56289	TE1162	C3-100M	27
C304	.001 μ f	1000 v	CerD	72982	801Z5V102P	C22-.001M	24
C305	.001 μ f	1000 v	CerD	72982	801Z5V102P	C22-.001M	24

DIODES

Circuit Desig.	Type	Number	Mfg. Code	Keithley Part No.	Fig. Ref.
D301	Silicon	1N3256	02735	RF-22	27
D302	Silicon	1N3256	02735	RF-22	27
D303	Silicon	1N3253	02735	RF-20	27

DIODES (Cont'd)

Circuit Desig.	Type	Number	Mfg. Code	Keithley Part No.	Fig. Ref.
D304	Silicon	1N3253	02735	RF-20	27
D305	Zener	1N3022A	04713	DZ-23	27

MISCELLANEOUS PARTS

Circuit Desig.	Description	Mfg. Code	Keithley Part No.	Fig. Ref.
B101	Mercury Cell, 1.35 v (Mfg. No. PX-13)	37942	BA-16	21
B102	Mercury Cell, 1.35 v (Mfg. No. PX-13)	37942	BA-16	21
E101	Photocell and Neon Lamp	27665	80164	23
E102	Photocell and Neon Lamp 4554	20573	80164	23
E103A	Photocell (Mfg. No. CL603CM)	02011	1515	21
E103B	Neon Lamp (Mfg. No. A072)	74276	1515	
F1(117 v)	Fuse, slow blow, 0.5 amp, (Mfg. Type MDL)	71400	FU-4	3
F1(234 v)	Fuse, slow blow, 0.25 amp (Mfg. No. 313.250)	75915	FU-17	3
—	Fuse Holder (Mfg. No. 342012)	75915	FH-3	
GL101	Neon Lamp (Mfg. No. NE-2U)	08804	PL-14	23
J1	Receptacle, Special, INPUT	80164	CS-140	2
—	Plug, Triaxial, Mate of J1	80164	Model 1533	
J2	Binding Post, DC OUTPUT (Mfg. No. DF21RC)	58474	BP-11R	3
J3	Binding Post, LO (Mfg. No. DF21BC)	58474	BP-11B	3
J4	Binding Post, G (Mfg. No. DF21GC)	58474	BP-11G	3
—	Shorting Link (Mfg. No. 938-L)	24655	BP-6	
L301	Choke, 2.5 mhy (Mfg. No. 6302-E)	76493	CH-7	24
L302	Choke, 2.5 mhy (Mfg. No. 6302-E)	76493	CH-7	24
M101	Meter	80164	ME-53A	
P1	Cord Set, 6 feet (Mfg. No. 4638-13)	93656	CO-5	3
S1	Rotary Switch less components, RANGE	80164	SW-201	2
—	Dial Assembly, Range Switch	80164	17026A	
S2	Rotary Switch, FUNCTION	80164	SW-199	2
—	Knob Assembly, Function Switch	80164	14838A	
S3	Rotary Switch, METER	80164	SW-200	2
—	Knob Assembly, Meter Switch	80164	18393A	

MISCELLANEOUS PARTS (Cont'd)

Circuit Desig.	Description	Mfg. Code	Keithley Part No.	Fig. Ref.
—	Knob, Zero Control	80164	16373A	
S4	Slide Switch, 117-234 v	80164	SW-151	3
T1	Transformer	80164	TR-91	27

RESISTORS

Circuit Desig.	Value	Rating	Type	Mfg. Code	Mfg. Part No.	Keithley Part No.	Fig. Ref.
R101	10 ⁹ Ω	20%, 1/2 w	Comp	75042	GBT	R37-10 ⁹	23
R102	270 kΩ	10%, 1/2 w	Comp	01121	EB	R1-270K	23
R103	270 kΩ	10%, 1/2 w	Comp	01121	EB	R1-270K	23
R104	270 kΩ	10%, 1/2 w	Comp	01121	EB	R1-270K	23
R105	1 kΩ	10%, 1/2 w	Comp	01121	EB	R1-1K	23
R106	6.5 MΩ	1%, 1/2 w	DCb	79727	CFE-15	R12-6.5M	22
R107	2.2 MΩ	1%, 1/2 w	DCb	79727	CFE-15	R12-2.2M	22
R108	1 MΩ	1%, 1 w	MtF	07716	CEC	R94-1M	22
R109	500 kΩ	1%, 1/2 w	DCb	79727	CFE-15	R12-500K	22
R110	*330 kΩ	10%, 1/4 w	Comp	44655	RC07	R76-330K	22
R111	47 kΩ	10%, 1/2 w	Comp	01121	EB	R1-47K	22
R112	470 kΩ	10%, 1/2 w	Comp	01121	EB	R1-470K	22
R113	470 kΩ	10%, 1/2 w	Comp	01121	EB	R1-470K	22
R114	5.6 kΩ	10%, 1/2 w	Comp	01121	EB	R1-5.6K	22
R115	2.2 MΩ	10%, 1/2 w	Comp	01121	EB	R1-2.2M	22
R116	680 kΩ	10%, 1/4 w	Comp	44655	RC07	R76-680K	22
R117	4.7 kΩ	10%, 1/2 w	Comp	01121	EB	R1-4.7K	22
R118	77.7 kΩ	0.5%, 1/2 w	MtF	07716	CEC	R61-77.7K	22
R119	77.7 kΩ	0.5%, 1/2 w	MtF	07716	CEC	R61-77.7K	22
R120	39.2 kΩ	0.5%, 1/2 w	MtF	07716	CEC	R61-39.2K	22
R121	2.2 MΩ	10%, 1/2 w	Comp	01121	EB	R1-2.2M	22
R122	47 kΩ	10%, 1/2 w	Comp	01121	EB	R1-47K	22
R123	2.2 kΩ	10%, 1/2 w	Comp	01121	EB	R1-2.2K	22
R124	100 kΩ	10%, 1/2 w	Comp	01121	EB	R1-100K	22
R125	10 kΩ	10%, 5 w	WWVar	71450	AW	RP34-10K	20
R126	2.7 MΩ	10%, 1/2 w	Comp	01121	EB	R1-2.7M	22
R127	*15 kΩ	10%, 1/4 w	Comp	01121	CB	R76-15K	22
R128	10 MΩ	10%, 1/4 w	Comp	44655	RC07	R76-10M	25
R129	10 MΩ	10%, 1/4 w	Comp	44655	RC07	R76-10M	25
R130	*10 MΩ	10%, 1/4 w	Comp	44655	RC07	R76-10M	25
R131	80 Ω	1/4%, 1/2 w	MtF	07716	CEC-TO	R127-80	26
R132	15 kΩ	10%, 5 w	WWVar	71450	AW	RP3-15K	3

*Nominal value, factory set.

RESISTORS (Cont'd)

Circuit Desig.	Value	Rating	Type	Mfg. Code	Mfg. Part No.	Keithley Part No.	Fig. Ref.
R133	2 M Ω	5%, 1 w	Comp	01121	GB	R102-2M	23
R134	100 M Ω	1%, 2 w	DCb	91637	DC-2	R14-100M	25
R135	100 M Ω	1%, 2 w	DCb	91637	DC-2	R14-100M	25
R136	196 k Ω	1%, 1/2 w	DCb	79727	CFE-15	R12-196K	25
R137	10 k Ω	20%, .2 w	CompV	71450	70	RP31-10K	20
R138	1 M Ω	1%, 1 w	MtF	07716	CEC	R94-1M	25
R139	100 k Ω	1%, 1 w	MtF	07716	CEC	R94-100K	26
R140	10 k Ω	1%, 1 w	MtF	07716	CEC	R94-10K	26
R141	1 k Ω	1%, 1 w	MtF	07716	CEC	R94-1K	26
R142	100 Ω	1%, 1 w	MtF	07716	CEC	R94-100	26
R143	10 Ω	1%, 1 w	MtF	07716	CEC	R126-10	26
R144	1 Ω	1%, 1 w	MtF	07716	CEC	R128-1	25
R145	680 k Ω	10%, 1/4 w	Comp	44655	RC07	R76-680K	25
R146	220 k Ω	10%, 1/4 w	Comp	44655	RC07	R76-220K	25
R147	68 k Ω	10%, 1/4 w	Comp	44655	RC07	R76-68K	25
R148	22 k Ω	10%, 1/4 w	Comp	44655	RC07	R76-22K	25
R149	6.8 k Ω	10%, 1/4 w	Comp	44655	RC07	R76-6.8K	25
R150	2.2 k Ω	10%, 1/4 w	Comp	44655	RC07	R76-2.2K	25
R151	680 Ω	10%, 1/4 w	Comp	44655	RC07	R76-680	25
R152	220 Ω	10%, 1/4 w	Comp	44655	RC07	R76-220	25
R153	120 Ω	10%, 1/2 w	Comp	01121	EB	R1-120	25
R154	95.3 k Ω	1%, 1/2 w	DCb	79727	CFE-15	R12-95.3K	22
R155	1 M Ω	20%, 1/2 w	CbVar	71450	45	RP13-1M	2
R156	95.3 k Ω	1%, 1/2 w	DCb	79727	CFE-15	R12-95.3K	22
R157	1 M Ω	1%, 1 w	MtF	07716	CEC	R94-1M	26
R158	1 k Ω	.25%, 1/2 w	MtF	07716	CEC-TO	R127-1K	20
R159	1.69 k Ω	1%, 1/2 w	DCb	79727	CFE-15	R12-1.69K	22
R160	1 M Ω	20%, .2 w	CompV	71450	70	RP31-1M	20
R161	1.69 k Ω	1%, 1/2 w	DCb	79727	CFE-15	R12-1.69K	22
R162	100 k Ω	10%, 1/4 w	Comp	44655	RC07	R76-100K	22
R163	15 k Ω	10%, 1/4 w	Comp	44655	RC07	R76-15K	22
R164	1.079 M	1/4%, 1/2 w	MtF	07716	CEC-TO	R127-1.079M	26
R165	359 k Ω	1/4%, 1/2 w	MtF	07716	CEC-TO	R127-359K	26
R166	107.0 k Ω	1/4%, 1/2 w	MtF	07716	CEC-TO	R127-107K	26
R167	35.0 k Ω	1/4%, 1/2 w	MtF	07716	CEC-TO	R127-35K	26
R168	9.80 k Ω	1/4%, 1/2 w	MtF	07716	CEC-TO	R127-9.8K	26
R169	2.60 k Ω	1/4%, 1/2 w	MtF	07716	CEC-TO	R127-2.6K	26
R170	187 k Ω	1%, 1/2 w	MtF	07716	CEC	R94-187K	26
R171	11.8 k Ω	1%, 1/2 w	MtF	07716	CEC	R94-11.8K	26
R172	9.9 k Ω			80164		18613A	22
R173	100 Ω			80164		18613A	22

RESISTORS (Cont'd)

Circuit Desig.	Value	Rating	Type	Mfg. Code	Mfg. Part No.	Keithley Part No.	Fig. Ref.
R174	3.01 k Ω	1%, 1/2 w	MtF	07716	CEC	R94-3.01K	22
R175	649 Ω	1%, 1/2 w	MtF	07716	CEC	R94-649	22
R176	500 Ω	10%, 5 w	WWVar	71450	AW	RP34-500	20
R177	100 k Ω	20%, .2 w	CompV	71450	70	RP31-100K	20
R178	80 Ω	1/4%, 1/2 w	MtF	07716	CEC-TO	R127-80.0	
R201	47 k Ω	10%, 1/2 w	Comp	01121	EB	R1-47k	27
R202	47 k Ω	10%, 1/2 w	Comp	01121	EB	R1-47k	27
R203	150 k Ω	10%, 1/2 w	Comp	01121	EB	R1-150K	27
R204	1.5 M Ω	1%, 1/2 w	DCb	79727	CFE-15	R12-1.5M	27
R205	150 k Ω	10%, 1/2 w	Comp	01121	EB	R1-150K	27
R206	1.5 M Ω	1%, 1/2 w	DCb	79727	CFE-15	R12-1.5M	27
R207	47 k Ω	10%, 1/2 w	Comp	01121	EB	R1-47K	27
R208	*75 k Ω	1%, 1/2 w	DCb	79727	CFE-15	R12-75K	27
R209	80 k Ω	1%, 1/2 w	DCb	79727	CFE-15	R12-80K	27
R210	25 k Ω	10%, 5 w	WWVar	71450	AW	RP34-25K	27
R301	3 k Ω	10%, 10 w	WW	56289	10E3R05T8	R115-3K	27
R302	30 Ω	10%, 5 w	WW	56289	57E	R96-30	27
R303	2 k Ω	10%, 10 w	WW	56289	10E3R05T8	R115-2K	27
R304	100 k Ω	1%, 1/2 w	DCb	79727	CFE-15	R12-100K	27
R305	1 M Ω	10%, 1/2 w	Comp	01121	EB	R1-1M	27
R306	124 k Ω	1%, 1/2 w	MtF	07716	CEC	R94-124K	27
R307	49.9 k Ω	1%, 1/2 w	MtF	07716	CEC	R94-49.9K	27
R308	33 Ω	10%, 1/4 w	Comp	44655	RC07	R76-33	27

VACUUM TUBES

Circuit Desig.	Number	Mfg. Code	Keithley Part No.	Fig. Ref.
V101	12AU7	80164	EV-12AU7	21
V102	7025	02735	EV-7025	21
V103	12AT7	73445	EV-12AT7	21
V201	12AU7	73445	EV-12AU7	19
V301	OB2	86684	EV-OB2	20
V302	OA2	86684	EV-OA2	20

*Nominal value, factory set.

